

# WHITLAM CHEMICAL AND PLUMB-PRO QUALITY TOOLS

Effective January 1, 2020  
List Price Catalog - 88L



**PLUMBING  
IRRIGATION  
UNDERGROUND UTILITIES  
INDUSTRIAL / FIRE PROTECTION  
POOL / SPA  
HVAC / REFRIGERATION**



The Industry Standard for Over 100 Years

J.C. WHITLAM MANUFACTURING CO.

200 WEST WALNUT STREET • P.O. BOX 380 • WADSWORTH, OHIO 44282-0380  
CALL: 1-800-321-8358 • FAX: 1-800-537-0588 U.S.A., PUERTO RICO, U.S. VIRGIN ISLANDS  
INTERNATIONAL CALL: 1-330-334-2524 • FAX: 1-330-334-3005

website: [www.jcwhitlam.com](http://www.jcwhitlam.com)  
email: [sales@jcwhitlam.com](mailto:sales@jcwhitlam.com)

POSSESSION OF THIS PRICE CATALOG SHALL NOT BE CONSTRUED AS AN OFFER TO SELL PRODUCTS LISTED.

<b>CATEGORY 1</b>	SOLVENT CEMENTS, PRIMERS, CLEANERS .....	3 - 7
<b>CATEGORY 2</b>	THREAD SEALANTS, THREAD SEALANT TAPE .....	8 - 10
<b>CATEGORY 3</b>	PUTTY, COATINGS, OIL, CAULKING GUNS .....	10 - 11
<b>CATEGORY 4</b>	DAP PRODUCTS .....	12
<b>CATEGORY 5</b>	ABRASIVE CLOTHS, FITTING BRUSHES, SOLDER FLUX, GREASE .....	13 - 14
<b>CATEGORY 6</b>	PIPE GASKET LUBRICANTS .....	14
<b>CATEGORY 7</b>	SYSTEM DESCALER, DESCALER KIT, PUMP & HOSES FOR DESCALER KIT, FLOW-AIDE DISPLAYS, TRAP PRIMER, URINAL ODOR BLOCKER, URINAL CLEANER, DRAIN OPENERS, DRAIN CLEANERS, HAND CLEANERS .....	15 - 16
<b>CATEGORY 8</b>	FLANGE BOLTS, HEX NUTS, WASHERS, WAX RINGS, TANK TO BOWL BOLT SETS, GASKETS, GASKET AND BOLT KITS .....	17 - 19
<b>CATEGORY 9</b>	ANTI-FREEZE & HEATING PRODUCTS .....	20 - 21
<b>CATEGORY 10</b>	HIGHSIDE CHEMICALS .....	22
<b>CATEGORY 11</b>	SCREWDRIVERS, STRAPS .....	23 - 24
<b>CATEGORY 12</b>	PICK MATTOCK, SLEDGE HAMMERS, SHOVELS, SPADES, SOIL PROBES, METER KEYS, VALVE WRENCHES .....	24 - 26
<b>CATEGORY 13</b>	PLIERS, PLUMBING WRENCHES, WATER HEATER ELEMENT WRENCH .....	27 - 28
<b>CATEGORY 14</b>	SAWS, PLASTIC PIPE CUTTERS, INTERNAL PIPE CUTTERS, PIPE FITTING REAMERS .....	29 - 32
<b>CATEGORY 15</b>	PIPE VENT SCREENS, INVERTED MARKING PAINT, MARKING GUN, MARKING WAND, MARKING MACHINE, TURF GREEN COLORANT, LEAK TRACER DYES .....	32 - 33
<b>CATEGORY 16</b>	CANS, DAUBERS, SWAB APPLICATORS, SPRAYERS, BOTTLES, INSPECTION MIRROR, BRUSHES, LEVELS, INSULATORS, STUD PUNCH, 4 WAY VALVE KEY, MEASURING TAPE, MASON TWINE, WIRE PULLING TWINE, PIPE WRAP TAPE, CAUTION TAPE, .....	34 - 35
<b>DISPLAYS</b>	.....	<b>36 - 40</b>
<b>WHITLAM HISTORY</b>	.....	<b>41</b>
<b>INDEX</b>	.....	<b>42 - 43</b>



**J.C. Whitlam Manufacturing** Headquarters consists of more than 100,000 square feet of offices, plant, warehousing and laboratory facilities in northeastern Ohio. Chemical containment tanks, shown above, allow proper storage and quick retrieval.



**PVC SOLVENT CEMENTS**



**PVC CLEAR REGULAR BODIED LOW VOC CEMENT\*** A fast set for use through 4" (10.16 cm) diameter Sch. 40 and 1-1/4" (3.17 cm) Sch. 80 PVC pressure pipe and through 6" (15.24 cm) diameter non-pressure pipe. Meets ASTM D2564. **MADE IN THE U.S.A.**

	STOCK CODE	SIZE	CONTAINER	ITEMS/CASE	CASE WEIGHT	LIST PRICE EACH
	PRL4	1/4 Pint - 118 ml	Dauber Top Can	24	10 lbs. - 4.5 kg	6.70
	PRL8	1/2 Pint - 237 ml	Dauber Top Can	24	16 lbs. - 7.3 kg	9.54
	PRL16	Pint - 473 ml	Dauber Top Can	12	15 lbs. - 6.8 kg	15.82
	PRL32	Quart - .95 L	Dauber Top Can	12	28 lbs. - 12.7 kg	26.86
	PRL1	Gallon - 3.785 L	Can w/Handle	6	56 lbs. - 25.4 kg	96.93
	PRL1-CGW	Gallon - 3.785 L	Wide Mouth Can w/Handle	6	56 lbs. - 25.4 kg	102.07



**PVC CLEAR MEDIUM BODIED LOW VOC CEMENT\*** A medium set for use through 6" (15.24 cm) diameter Sch. 40 & Sch. 80 PVC pressure pipe and through 8" (20.32 cm) diameter non-pressure pipe. Meets ASTM D2564. **MADE IN THE U.S.A.**

	STOCK CODE	SIZE	CONTAINER	ITEMS/CASE	CASE WEIGHT	LIST PRICE EACH
	PL4	1/4 Pint - 118 ml	Dauber Top Can	24	10 lbs. - 4.5 kg	7.59
	PL8	1/2 Pint - 237 ml	Dauber Top Can	24	16 lbs. - 7.3 kg	12.22
	PL16	Pint - 473 ml	Dauber Top Can	12	15 lbs. - 6.8 kg	18.20
	PL32	Quart - .95 L	Dauber Top Can	12	29 lbs. - 13.2 kg	31.23
	PL1	Gallon - 3.785 L	Can w/Handle	6	56 lbs. - 25.4 kg	117.36
	PL1-CGW	Gallon - 3.785 L	Wide Mouth Can w/Handle	6	56 lbs. - 25.4 kg	122.49



**PVC CLEAR HEAVY DUTY LOW VOC CEMENT\*** A medium set for use through 12" (30.48 cm) diameter Sch. 40 & Sch. 80 PVC pressure pipe and through 16" (40.64 cm) diameter non-pressure pipe. Recommended as a One-Step Solvent Weld Cement for Drain, Waste and Vent (DWV) pipe and fittings in non-pressure applications in sizes up to 4" (10.16 cm) where acceptable by local code. Meets ASTM D2564. **MADE IN THE U.S.A.**

	STOCK CODE	SIZE	CONTAINER	ITEMS/CASE	CASE WEIGHT	LIST PRICE EACH
	HDP4	1/4 Pint - 118 ml	Dauber Top Can	24	10 lbs. - 4.5 kg	7.97
	HDP8	1/2 Pint - 237 ml	Dauber Top Can	24	16 lbs. - 7.3 kg	12.38
	HDP16	Pint - 473 ml	Dauber Top Can	12	15 lbs. - 6.8 kg	18.89
	HDP32	Quart - .95 L	Dauber Top Can	12	29 lbs. - 13.2 kg	32.61
	HDP1	Gallon - 3.785 L	Can w/Handle	6	56 lbs. - 25.4 kg	120.42
	HDP1-CGW	Gallon - 3.785 L	Wide Mouth Can w/Handle	6	56 lbs. - 25.4 kg	125.52



**PVC CLEAR HEAVY BODIED LOW VOC CEMENT\*** A slow set for use through 12" (30.48 cm) diameter Sch. 40 & Sch. 80 PVC pressure pipe and through 16" (40.64 cm) diameter non-pressure pipe. Meets ASTM D2564. **MADE IN THE U.S.A.**

	STOCK CODE	SIZE	CONTAINER	ITEMS/CASE	CASE WEIGHT	LIST PRICE EACH
	HPL16	Pint - 473 ml	Dauber Top Can	12	15 lbs. - 6.8 kg	19.58
	HPL32	Quart - .95 L	Dauber Top Can	12	28 lbs. - 12.7 kg	33.95
	HPL1	Gallon - 3.785 L	Can w/Handle	6	56 lbs. - 25.4 kg	123.49
	HPL1-CGW	Gallon - 3.785 L	Wide Mouth Can w/Handle	6	56 lbs. - 25.4 kg	128.62



**PVC GRAY MEDIUM BODIED LOW VOC CEMENT\*** A medium set for use through 6" (15.24 cm) diameter Sch. 40 & Sch. 80 PVC pressure pipe and through 8" (20.32 cm) diameter non-pressure pipe. Meets ASTM D2564. **MADE IN THE U.S.A.**

	STOCK CODE	SIZE	CONTAINER	ITEMS/CASE	CASE WEIGHT	LIST PRICE EACH
	GL4	1/4 Pint - 118 ml	Dauber Top Can	24	10 lbs. - 4.5 kg	7.43
	GL8	1/2 Pint - 237 ml	Dauber Top Can	24	16 lbs. - 7.3 kg	11.80
	GL16	Pint - 473 ml	Dauber Top Can	12	16 lbs. - 7.3 kg	17.66
	GL32	Quart - .95 L	Dauber Top Can	12	28 lbs. - 12.7 kg	30.08
	GL1	Gallon - 3.785 L	Can w/Handle	6	56 lbs. - 25.4 kg	118.12
	GL1-CGW	Gallon - 3.785 L	Wide Mouth Can w/Handle	6	56 lbs. - 25.4 kg	123.26



**PVC GRAY SCH. 80 HEAVY BODIED LOW VOC CEMENT\*** A slow set for use through 12" (30.48 cm) diameter Sch. 40 & Sch. 80 PVC pressure pipe and through 16" (40.64 cm) diameter non-pressure pipe. Meets ASTM D2564. **MADE IN THE U.S.A.**

	STOCK CODE	SIZE	CONTAINER	ITEMS/CASE	CASE WEIGHT	LIST PRICE EACH
	PGL16	Pint - 473 ml	Dauber Top Can	12	16 lbs. - 7.3 kg	23.30
	PGL32	Quart - .95 L	Dauber Top Can	12	28 lbs. - 12.7 kg	38.12
	PGL1	Gallon - 3.785 L	Can w/Handle	6	56 lbs. - 25.4 kg	135.13
	PGL1-CGW	Gallon - 3.785 L	Wide Mouth Can w/Handle	6	56 lbs. - 25.4 kg	140.27



**PVC WHITE EXTRA HEAVY BODIED LOW VOC CEMENT\*** A slow set for use through 30" (76.2 cm) diameter Sch. 40 & Sch. 80 PVC pressure pipe. Meets ASTM D2564. **MADE IN THE U.S.A.**

	STOCK CODE	SIZE	CONTAINER	ITEMS/CASE	CASE WEIGHT	LIST PRICE EACH
	XHW32	Quart - .95 L	Flat Top Can	12	29 lbs. - 13.2 kg	73.72
	XHW1	Gallon - 3.785 L	Paint Can w/Handle	4	37 lbs. - 16.8 kg	203.79
	XHW55	55 Gallon - 208 L	Drum	1	498 lbs. - 225.9 kg	9518.89

\*D.O.T. Classified Shipping Items. See Page 39.  
Pallet Quantities for Plastic Solvent Cements & Cleaners: 1/4 Pint = 130 Cases, 1/2 Pint = 80 Cases, 1 Pint = 80 Cases, 1 Quart = 56 Cases, 1 Gallon = 27 Cases.

**PVC SOLVENT CEMENTS**

**PVC GRAY EXTRA HEAVY BODIED LOW VOC CEMENT\*** A slow set for use through 30" (76.2 cm) diameter Sch. 40 & Sch. 80 PVC pressure pipe. Meets ASTM D2564. **MADE IN THE U.S.A.**



STOCK CODE	SIZE	CONTAINER	ITEMS/CASE	CASE WEIGHT	LIST PRICE EACH
XHG32	Quart - .95 L	Flat Top Can	12	29 lbs. - 13.2 kg	77.43
XHG1	Gallon - 3.785 L	Paint Can w/Handle	4	37 lbs. - 16.8 kg	213.95
XHG55	55 Gallon - 208 L	Drum	1	498 lbs. - 225.9 kg	9994.87



**"WEATHERPROOF" CLEAR MEDIUM BODIED WET/DRY LOW VOC PVC CEMENT\*** A fast one step\*\* cement for use on all classes and schedules of PVC pressure pipe (including Sch. 80) through 6" (15.24 cm) diameter and on non-pressure systems through 8" (20.32 cm) diameter. Meets ASTM D2564. **MADE IN THE U.S.A.**



PCW4	1/4 Pint - 118 ml	Dauber Top Can	24	10 lbs. - 4.5 kg	8.85
PCW8	1/2 Pint - 237 ml	Dauber Top Can	24	16 lbs. - 7.3 kg	14.37
PCW16	Pint - 473 ml	Dauber Top Can	12	15 lbs. - 6.8 kg	21.23
PCW32	Quart - .95 L	Dauber Top Can	12	28 lbs. - 12.7 kg	35.86
PCW1	Gallon - 3.785 L	Can w/Handle	6	56 lbs. - 25.4 kg	139.66
PCW1-CGW	Gallon - 3.785 L	Wide Mouth Can w/Handle	6	56 lbs. - 25.4 kg	144.79



**"WEATHERPROOF" BLUE MEDIUM BODIED WET/DRY LOW VOC PVC CEMENT\*** A fast one step\*\* cement for use on all classes and schedules of PVC pressure pipe (including Sch. 80) through 6" (15.24 cm) diameter and on non-pressure systems through 8" (20.32 cm) diameter. Meets ASTM D2564. **MADE IN THE U.S.A.**



WET4	1/4 Pint - 118 ml	Dauber Top Can	24	10 lbs. - 4.5 kg	8.81
WET8	1/2 Pint - 237 ml	Dauber Top Can	24	16 lbs. - 7.3 kg	15.06
WET8A	1/2 Pint - 237 ml	Dauber Top Can (Display Box)	12	9 lbs. - 4.1 kg	16.48
WET16	Pint - 473 ml	Dauber Top Can	12	15 lbs. - 6.8 kg	24.02
WET32	Quart - .95 L	Dauber Top Can	12	28 lbs. - 12.7 kg	40.84
WET1	Gallon - 3.785 L	Can w/Handle	6	56 lbs. - 25.4 kg	141.38
WET1-CGW	Gallon - 3.785 L	Wide Mouth Can w/Handle	6	56 lbs. - 25.4 kg	146.51



**"TURF-POL & REPAIR" AQUA BLUE MEDIUM BODIED LOW VOC PVC CEMENT\*** A fast set for use through 3" (7.62 cm) diameter on all classes of PVC pressure pipe (except Sch. 80) and 6" (15.24 cm) diameter on non-pressure PVC pipe where pipe pulling is required and conditions are wet and/or quick pressurization is needed. Meets ASTM D2564. **MADE IN THE U.S.A.**



TP8	1/2 Pint - 237 ml	Dauber Top Can	24	16 lbs. - 7.3 kg	15.06
TP16	Pint - 473 ml	Dauber Top Can	12	15 lbs. - 6.8 kg	24.02
TP32	Quart - .95 L	Dauber Top Can	12	28 lbs. - 12.7 kg	40.84
TP1	Gallon - 3.785 L	Can w/Handle	6	56 lbs. - 25.4 kg	141.38
TP1-CGW	Gallon - 3.785 L	Wide Mouth Can w/Handle	6	56 lbs. - 25.4 kg	146.51



**"PRO-GREEN" IRRIGATION, MEDIUM BODIED LOW VOC PVC CEMENT\*** A fast one step\*\* cement for use through 3" (7.62 cm) diameter on all classes of PVC pressure pipe (except Sch. 80), and 6" (15.24 cm) diameter on non-pressure PVC pipe where pipe pulling is required and conditions are wet and/or quick pressurization is needed. Meets ASTM D2564. **MADE IN THE U.S.A.**



IR4	1/4 Pint - 118 ml	Dauber Top Can	24	10 lbs. - 4.5 kg	8.81
IR8	1/2 Pint - 237 ml	Dauber Top Can	24	16 lbs. - 7.3 kg	15.06
IR8A	1/2 Pint - 237 ml	Dauber Top Can (Display Box)	12	9 lbs. - 4.1 kg	16.48
IR16	Pint - 473 ml	Dauber Top Can	12	15 lbs. - 6.8 kg	24.02
IR32	Quart - .95 L	Dauber Top Can	12	28 lbs. - 12.7 kg	40.84
IR1	Gallon - 3.785 L	Can w/Handle	6	56 lbs. - 25.4 kg	141.38
IR1-CGW	Gallon - 3.785 L	Wide Mouth Can w/Handle	6	56 lbs. - 25.4 kg	146.51



**"SHARK-BITE" AQUA BLUE MEDIUM BODIED POOL/SPA LOW VOC PVC CEMENT\*** A one step\*\* cement for use through 3" (7.62 cm) diameter on all classes of PVC pressure pipe (except Sch. 80), and 6" (15.24 cm) diameter on non-pressure PVC pipe. Meets ASTM D2564. **MADE IN THE U.S.A.**



SB4	1/4 Pint - 118 ml	Dauber Top Can	24	10 lbs. - 4.5 kg	8.81
SB8	1/2 Pint - 237 ml	Dauber Top Can	24	16 lbs. - 7.3 kg	15.06
SB8A	1/2 Pint - 237 ml	Dauber Top Can (Display Box)	12	9 lbs. - 4.1 kg	16.48
SB16	Pint - 473 ml	Dauber Top Can	12	15 lbs. - 6.8 kg	24.02
SB32	Quart - .95 L	Dauber Top Can	12	28 lbs. - 12.7 kg	40.84
SB1	Gallon - 3.785 L	Can w/Handle	6	56 lbs. - 25.4 kg	141.38
SB1-CGW	Gallon - 3.785 L	Wide Mouth Can w/Handle	6	56 lbs. - 25.4 kg	146.51



\* D.O.T. Classified Shipping Items. See Page 39.  
 \*\* Suitable to be used as a One-Step Cement for joining PVC Drain, Waste and Vent (DWV) pipe and fittings in non-pressure applications in sizes up to and including 4 inches where acceptable by local code.  
 Pallet Quantities for Plastic Solvent Cements & Cleaners: 1/4 Pint = 130 Cases, 1/2 Pint = 80 Cases, 1 Pint = 80 Cases, 1 Quart = 56 Cases, 1 Gallon = 27 Cases.

**CPVC SOLVENT CEMENTS**



**CPVC YELLOW MEDIUM BODIED LOW VOC CEMENT\*** Use through 2" (5.08 cm) diameter CPVC pipe, CTS (copper tube size) and potable water pressure pipe. Medium bodied cement for use on CPVC and FlowGuard Gold® pipe and fittings. Exceeds ASTM F493 and ASTM D2846. **MADE IN THE U.S.A.**



STOCK CODE	SIZE	CONTAINER	ITEMS/CASE	CASE WEIGHT	LIST PRICE EACH
CPL4	1/4 Pint - 118 ml	Dauber Top Can	24	10 lbs. - 4.5 kg	10.69
CPL8	1/2 Pint - 237 ml	Dauber Top Can	24	16 lbs. - 7.3 kg	15.98
CPL16	Pint - 473 ml	Dauber Top Can	12	15 lbs. - 6.8 kg	27.62
CPL32	Quart - .95 L	Dauber Top Can	12	28 lbs. - 12.7 kg	45.94



**CPVC ORANGE MEDIUM BODIED LOW VOC CEMENT\*** Use through 6" (15.24 cm) diameter Sch. 40 CPVC pipe and through 1-1/2" (3.81 cm) diameter Sch. 80 CPVC pipe. Meets ASTM F493 and ASTM D2846. **MADE IN THE U.S.A.**



CPV4	1/4 Pint - 118 ml	Dauber Top Can	24	10 lbs. - 4.5 kg	9.66
CPV8	1/2 Pint - 237 ml	Dauber Top Can	24	16 lbs. - 7.3 kg	14.64
CPV16	Pint - 473 ml	Dauber Top Can	12	15 lbs. - 6.8 kg	25.17
CPV32	Quart - .95 L	Dauber Top Can	12	28 lbs. - 12.7 kg	41.76



**CPVC GRAY HEAVY BODIED LOW VOC CEMENT\*** Use through 12" (30.48 cm) diameter Sch. 40 CPVC pipe and through 6" (15.24 cm) diameter Sch. 80 CPVC pipe. Meets ASTM F493 and ASTM D2846. **MADE IN THE U.S.A.**



CPG16	Pint - 473 ml	Dauber Top Can	12	15 lbs. - 6.8 kg	27.05
CPG32	Quart - .95 L	Dauber Top Can	12	29 lbs. - 13.2 kg	46.25
CPG1	Gallon - 3.785 L	Can w/Handle	6	56 lbs. - 25.4 kg	161.26
CPG1-CGW	Gallon - 3.785 L	Wide Mouth Can w/Handle	6	56 lbs. - 25.4 kg	166.36

**ABS SOLVENT CEMENTS**



**ABS BLACK MEDIUM BODIED LOW VOC CEMENT\*** Use through 6" (15.24 cm) diameter ABS pressure and DWV pipe. Meets ASTM D2235. **MADE IN THE U.S.A.**  
Also available in **LOW VOC ABS Yellow Cement. Stock Code ABS.**



AL4	1/4 Pint - 118 ml	Dauber Top Can	24	10 lbs. - 4.5 kg	6.36
AL8	1/2 Pint - 237 ml	Dauber Top Can	24	16 lbs. - 7.3 kg	9.62
AL16	Pint - 473 ml	Dauber Top Can	12	15 lbs. - 6.8 kg	15.94
AL32	Quart - .95 L	Dauber Top Can	12	28 lbs. - 12.7 kg	26.55
AL1	Gallon - 3.785 L	Can w/Handle	6	56 lbs. - 25.4 kg	91.23
AL1-CGW	Gallon - 3.785 L	Wide Mouth Can w/Handle	6	56 lbs. - 25.4 kg	96.36

**ALL PURPOSE SOLVENT CEMENTS**



**ALL PURPOSE CLEAR REGULAR BODIED LOW VOC CEMENT\*** Use through 4" (10.16 cm) diameter Sch. 40 & Sch. 80 ABS, PVC and Sch. 40 CPVC pipe. **MADE IN THE U.S.A.**



APR4	1/4 Pint - 118 ml	Dauber Top Can	24	10 lbs. - 4.5 kg	7.97
APR8	1/2 Pint - 237 ml	Dauber Top Can	24	16 lbs. - 7.3 kg	12.18
APR16	Pint - 473 ml	Dauber Top Can	12	15 lbs. - 6.8 kg	21.84
APR32	Quart - .95 L	Dauber Top Can	12	28 lbs. - 12.7 kg	35.94
APR1	Gallon - 3.785 L	Can w/Handle	6	56 lbs. - 25.4 kg	138.20
APR1-CGW	Gallon - 3.785 L	Wide Mouth Can w/Handle	6	56 lbs. - 25.4 kg	143.33



**ALL PURPOSE CLEAR, MEDIUM BODIED, HEAVY DUTY LOW VOC CEMENT\*** Use through 6" (15.24 cm) diameter Sch. 40 & Sch. 80 ABS, PVC and CPVC Pipe. **MADE IN THE U.S.A.**



AP4	1/4 Pint - 118 ml	Dauber Top Can	24	10 lbs. - 4.5 kg	9.54
AP8	1/2 Pint - 237 ml	Dauber Top Can	24	16 lbs. - 7.3 kg	14.48
AP16	Pint - 473 ml	Dauber Top Can	12	15 lbs. - 6.8 kg	24.98
AP32	Quart - .95 L	Dauber Top Can	12	28 lbs. - 12.7 kg	41.69

FlowGuard Gold® is a Registered Trademark of The Lubrizol Corporation.

\*D.O.T. Classified Shipping Items. See Page 39.

Pallet Quantities for Plastic Solvent Cements & Cleaners: 1/4 Pint = 130 Cases, 1/2 Pint = 80 Cases, 1 Pint = 80 Cases, 1 Quart = 56 Cases, 1 Gallon = 27 Cases.



**TRANSITION SOLVENT CEMENT**

**“SWITCH” TRANSITION GREEN MEDIUM BODIED LOW VOC CEMENT\*** A fast set cement for use through 6" (15.24 cm) diameter for joining ABS pipe or fittings to PVC pipe or fittings. Meets ASTM D3138. **MADE IN THE U.S.A.**



STOCK CODE	SIZE	CONTAINER	ITEMS/CASE	CASE WEIGHT	LIST PRICE EACH
TC16	Pint - 473 ml	Dauber Top Can	12	15 lbs. - 6.8 kg	19.92
TC32	Quart - .95 L	Dauber Top Can	12	28 lbs. - 12.7 kg	32.18



**PRIMERS**

**LOW VOC CLEAR PRIMER\*** For use on all PVC, ABS and CPVC pipe and fittings. Meets ASTM F656. **MADE IN THE U.S.A.**



PCL4	1/4 Pint - 118 ml	Dauber Top Can	24	9 lbs. - 4.1 kg	7.97
PCL8	1/2 Pint - 237 ml	Dauber Top Can	24	15 lbs. - 6.8 kg	10.54
PCL16	Pint - 473 ml	Dauber Top Can	12	14 lbs. - 6.4 kg	17.09
PCL32	Quart - .95 L	Dauber Top Can	12	26 lbs. - 11.8 kg	29.39
PCL1	Gallon - 3.785 L	Can w/Handle	6	50 lbs. - 22.7 kg	99.23
PCL1-CGW	Gallon - 3.785 L	Wide Mouth Can w/Handle	6	50 lbs. - 22.7 kg	104.37



**LOW VOC PURPLE PRIMER\*** For use on all PVC, ABS and CPVC pipe and fittings. Dyes plastic purple. Meets ASTM F656. **MADE IN THE U.S.A.**



PPL4	1/4 Pint - 118 ml	Dauber Top Can	24	9 lbs. - 4.1 kg	8.01
PPL8	1/2 Pint - 237 ml	Dauber Top Can	24	15 lbs. - 6.8 kg	10.69
PPL16	Pint - 473 ml	Dauber Top Can	12	14 lbs. - 6.4 kg	17.51
PPL32	Quart - .95 L	Dauber Top Can	12	26 lbs. - 11.8 kg	30.08
PPL1	Gallon - 3.785 L	Can w/Handle	6	50 lbs. - 22.7 kg	101.61
PPL1-CGW	Gallon - 3.785 L	Wide Mouth Can w/Handle	6	50 lbs. - 22.7 kg	106.74



**CLEANERS**

**LOW VOC CLEAR CLEANER\*** For use on all PVC, ABS and CPVC pipe and fittings. **MADE IN THE U.S.A.**



C4	1/4 Pint - 118 ml	Dauber Top Can	24	9 lbs. - 4.1 kg	7.66
C8	1/2 Pint - 237 ml	Dauber Top Can	24	15 lbs. - 6.8 kg	10.61
C16	Pint - 473 ml	Dauber Top Can	12	14 lbs. - 6.4 kg	15.10
C32	Quart - .95 L	Dauber Top Can	12	25 lbs. - 11.3 kg	23.52
C1	Gallon - 3.785 L	Can w/Handle	6	50 lbs. - 22.7 kg	87.28
C1-CGW	Gallon - 3.785 L	Wide Mouth Can w/Handle	6	50 lbs. - 22.7 kg	92.41



**Average Joint Cure Schedule For WHITLAM PVC/CPVC Solvent Cements\*\***

Relative Humidity 60% or Less	Cure Time Pipe Sizes 1/2" to 1 1/4"		Cure Time Pipe Sizes 1 1/2" to 2"		Cure Time Pipe Sizes 2 1/2" to 8"		Cure Time Pipe Sizes 10" to 15"		Cure Time Pipe Sizes 15"+
	up to 160 psi	160 to 370 psi	up to 160 psi	above 160 to 315 psi	up to 160 psi	above 160 to 315 psi	up to 100 psi	up to 100 psi	
60°-100°F	15 min	6 hrs	30 min	12 hrs	1 1/2 hrs	24 hrs	48 hrs	72 hrs	
40°- 60°F	20 min	12 hrs	45 min	24 hrs	4 hrs	48 hrs	96 hrs	6 days	
0°- 40°F	30 min	48 hrs	1 hour	96 hrs	72 hrs	8 days	8 days	14 days	

Note-Joint cure schedule is the necessary time to allow before pressurizing system. In damp or humid weather allow 50% more cure time.

\*\* These figures are estimates based on our laboratory tests; extended cure times are required for chemical applications. Due to the many variables in the field, these figures should be used as a general guide only.

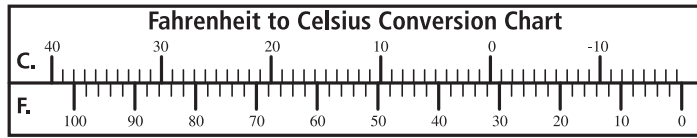

**3 YEAR LIMITED WARRANTY**

Whitlam Cements, Primers and Cleaners are made with the highest quality materials and meet or exceed their relative ASTM Specifications. All information provided is based on our laboratory testing, independent laboratory test results, and actual field experience. Properly used, Whitlam Cements, Primers and Cleaners will perform in accordance with applicable standards. Whitlam Cements, Primers and Cleaners will maintain a 3 year shelf life from date of manufacture if unopened or unused. Since we are unable to control conditions for with the product is being used, our only obligation will be the replacement of the product. See the Limited and Guaranteed Sale and Return Policy for additional information.

\*D.O.T. Classified Shipping Items. See Page 39.  
Pallet Quantities for Plastic Solvent Cements & Cleaners: 1/4 Pint = 130 Cases, 1/2 Pint = 80 Cases, 1 Pint = 80 Cases, 1 Quart = 56 Cases, 1 Gallon = 27 Cases.

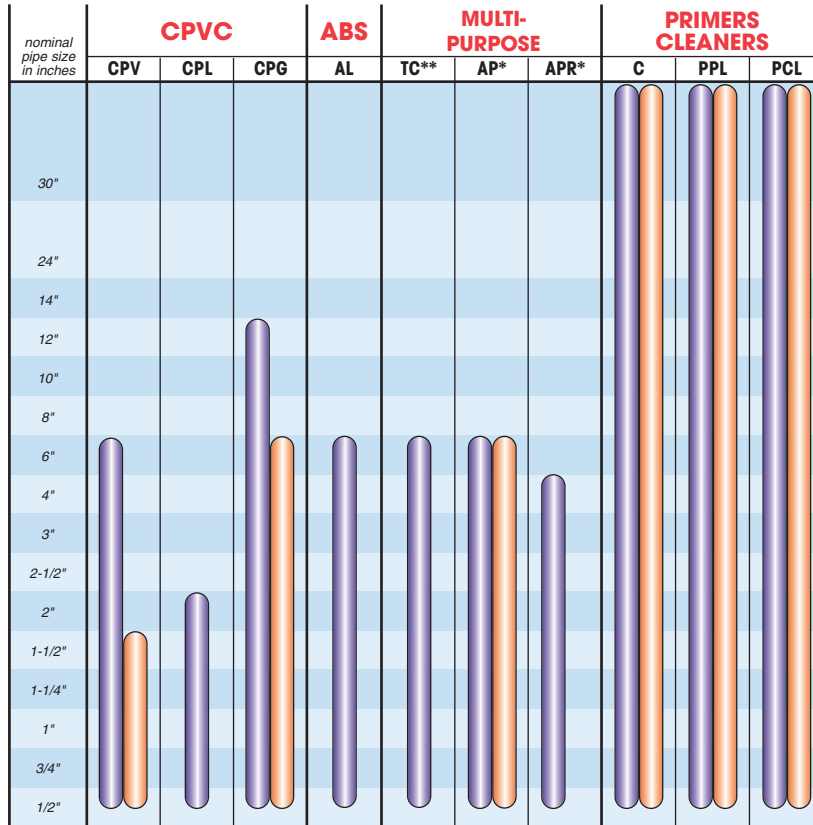
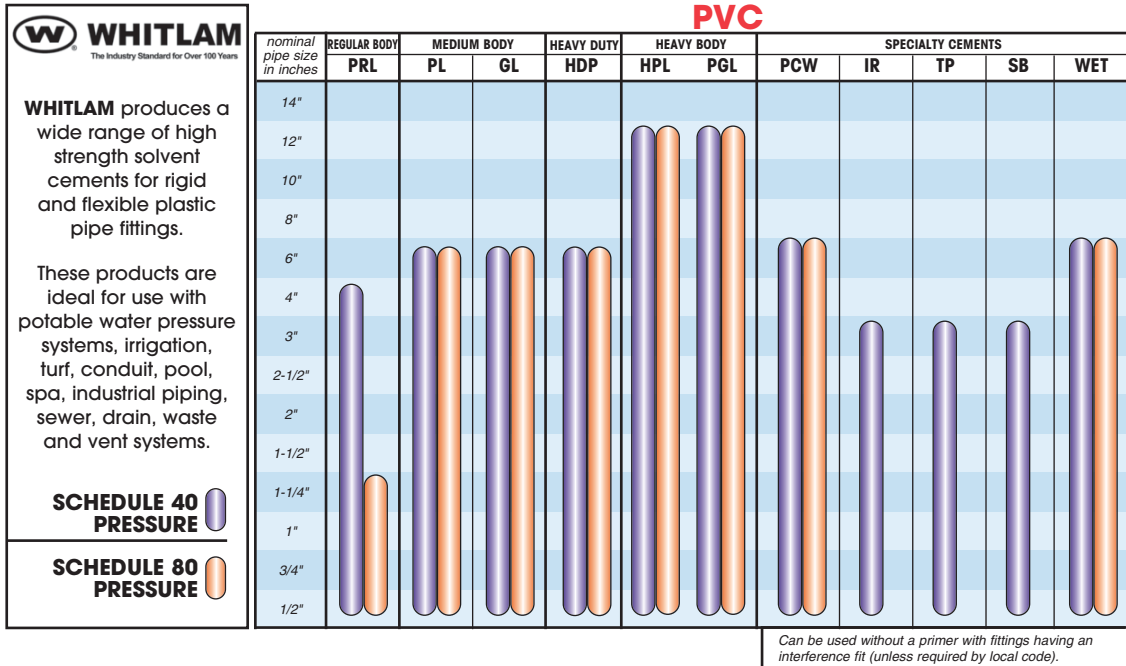

**Average Initial Set Schedule For WHITLAM PVC/CPVC Solvent Cements\*\***

Temperature Range	Pipe Sizes 1/2" to 1 1/4"	Pipe Sizes 1 1/2" to 2"	Pipe Sizes 2 1/2" to 8"	Pipe Sizes 10" to 15"	Pipe Sizes 15"+
60°-100°F	2 minutes	5 minutes	30 minutes	2 hours	4 hours
40°- 60°F	5 minutes	10 minutes	2 hours	8 hours	16 hours
0°- 40°F	10 minutes	15 minutes	12 hours	24 hours	48 hours

Note - Initial set schedule is the necessary time to allow before the joint can be carefully handled. In damp or humid weather allow 50% more set time.

\*\* These figures are estimates based on our laboratory tests using water; extended set times are required for chemical applications. Due to the many variables in the field, these figures should be used as a general guide only.

**Average Number of Joints Per Quart of WHITLAM Cement and Primer\***

Pipe Diameter	1/2"	3/4"	1"	1 1/2"	2"	3"	4"	6"	8"	10"	12"	15"	18"
Number of Joints	300	200	125	90	60	40	30	10	5	2-3	1-2	3/4	1/2

For Primer: Double the number of joints shown for cement. \*These figures are estimates based on our laboratory tests. Due to the many variables in the field, these figures should be used as a general guide only. Note: 1 Joint = 1 Socket

**THREAD SEALANTS**

**TYTE-UNYTE®** Non-hardening Gray Pipe Joint Compound in paste form. No Drip, Thixotropic Formula. For Air, Steam, Natural Gas and Water. "Standard of the Industry Since 1900." For use on all metal threads. Meets Federal Specification TT-A-580D. **MADE IN THE U.S.A.**

STOCK CODE	SIZE	CONTAINER	ITEMS/CASE	CASE WEIGHT	LIST PRICE EACH
T2*	2 oz. - .056 kg	Tube**	72	10 lbs. - 4.5 kg	2.55
T8	1/2 Pint/1 lb. - .454 kg	Brush Top Can	24	26 lbs. - 11.8 kg	6.33
T8C*	1/2 Pint/1 lb. - .454 kg	Brush Top Can	24	26 lbs. - 11.8 kg	6.33
T16	Pint/2 lbs. - .92 kg	Brush Top Can	12	25 lbs. - 11.3 kg	9.68
T6	6 lbs. - 2.72 kg	Pail w/Handle	4	31 lbs. - 14.1 kg	22.59
T50	50 lbs./5 gal. - 22.68 kg	Pail w/Handle	1	54 lbs. - 24.5 kg	192.33
T600	600 lbs./55 gal. - 208 L	55 Gallon Drum	1	640 lbs. - 290.3 kg	1862.78



**STEEL-UNYTE** Pipe Joint, Thread and Hard Set Sealer, Dark Gray, Semi-Paste for use on all Metal Threaded Connections and Flanges. Meets Military Specification MIL-S-7916B. Meets International Fuel Gas Code 403.9.3 for Thread Joint Compounds. **MADE IN THE U.S.A.**

ST4	1/4 Pint - 118 ml	Brush Top Can	24	14 lbs. - 6.4 kg	10.29
ST8	1/2 Pint - 237 ml	Brush Top Can	24	23 lbs. - 10.4 kg	15.37
ST8A	1/2 Pint - 237 ml	Brush Top Can (Display Box)	12	11 lbs. - 5.0 kg	16.76
ST16	Pint - 473 ml	Brush Top Can	12	22 lbs. - 10.0 kg	24.74
ST32	Quart - .95 L	Brush Top Can	12	43 lbs. - 19.5 kg	39.30
ST5	5 Gallon - 18.9 L	Pail w/Handle	1	65 lbs. - 29.5 kg	540.88
ST55	55 Gallon - 208 L	55 Gallon Drum	1	640 lbs. - 290.3 kg	4411.07



**T-U TYPE 555** Soft-Set, Yellow Thread Sealing Compound for use on Plastic and Metal Threaded Systems carrying Air, Steam, Petroleum, Water, Gases and many Chemicals. Meets Federal Specification TT-S-1732. Meets International Fuel Gas Code 403.9.3 for Thread Joint Compounds. **MADE IN THE U.S.A.**

TU4	1/4 Pint - 118 ml	Brush Top Can	24	14 lbs. - 6.4 kg	9.42
TU8	1/2 Pint - 237 ml	Brush Top Can	24	23 lbs. - 10.4 kg	16.50
TU8A	1/2 Pint - 237 ml	Brush Top Can (Display Box)	12	11 lbs. - 5.0 kg	18.03
TU16	Pint - 473 ml	Brush Top Can	12	22 lbs. - 10.0 kg	26.45
TU32	Quart - .95 L	Brush Top Can	12	41 lbs. - 18.6 kg	48.36
TU5	5 Gallon - 18.9 L	Pail w/Handle	1	65 lbs. - 29.5 kg	612.64
TU55	55 Gallon - 208 L	55 Gallon Drum	1	640 lbs. - 290.3 kg	5213.82
TU8C*	1/2 Pint - 237 ml	Brush Top Can	24	23 lbs. - 10.4 kg	18.03



**BLUE MAGIC** All Purpose, Non-seizing, Industrial Grade Pipe Thread Compound that produces a leakproof seal on all types of metal and plastic threaded connections. Suitable for ABS, PVC, and CPVC threaded connections. Approved for use on Spears FlameGuard® CPVC Systems. Meets Federal Specification TT-S-1732. Meets International Fuel Gas Code 403.9.3 for Thread Joint Compounds. **MADE IN THE U.S.A.**

IG2	2 oz. - .056 kg	Tube**	72	11 lbs. - 5.0 kg	5.07
IG4	1/4 Pint - 118 ml	Brush Top Can	24	15 lbs. - 6.8 kg	9.75
IG8	1/2 Pint - 237 ml	Brush Top Can	24	24 lbs. - 10.9 kg	15.51
IG8A	1/2 Pint - 237 ml	Brush Top Can (Display Box)	12	13 lbs. - 5.9 kg	16.83
IG16	Pint - 473 ml	Brush Top Can	12	22 lbs. - 10.0 kg	25.70
IG32	Quart - .95 L	Brush Top Can	12	42 lbs. - 19.1 kg	46.17
IG5	5 Gallon - 18.9 L	Pail w/Handle	1	65 lbs. - 29.5 kg	585.28
IG55	55 Gallon - 208 L	55 Gallon Drum	1	640 lbs. - 290.3 kg	5307.04
IG8C*	1/2 Pint - 237 ml	Brush Top Can	24	24 lbs. - 10.9 kg	15.51
IG8CA*	1/2 Pint - 237 ml	Brush Top Can (Display Box)	12	13 lbs. - 5.9 kg	16.83
IG16C*	Pint - 473 ml	Brush Top Can	12	22 lbs. - 10.0 kg	25.70



**SELECT-UNYTE** Soft-Set, White All Purpose PTFE Paste Thread Sealing Compound. For use on plastic and metal threaded systems carrying air, steam, petroleum, water, gases and many chemicals. Meets Federal Specification TT-S-1732. Meets International Fuel Gas Code 403.9.3 for Thread Joint Compounds. **MADE IN THE U.S.A.**

TF2	2 oz. - .056 kg	Tube**	72	11 lbs. - 5.0 kg	5.42
TF4	1/4 Pint - 118 ml	Brush Top Can	24	15 lbs. - 6.8 kg	9.63
TF8	1/2 Pint - 237 ml	Brush Top Can	24	23 lbs. - 10.4 kg	17.18
TF8A	1/2 Pint - 237 ml	Brush Top Can (Display Box)	12	13 lbs. - 5.9 kg	18.88
TF16	Pint - 473 ml	Brush Top Can	12	22 lbs. - 10.0 kg	28.43
TF32	Quart - .95 L	Brush Top Can	12	43 lbs. - 19.5 kg	52.15
TF5	5 Gallon - 18.9 L	Pail w/Handle	1	66 lbs. - 29.9 kg	662.29
TF55	55 Gallon - 208 L	55 Gallon Drum	1	640 lbs. - 290.3 kg	5803.02
TF8C*	1/2 Pint - 237 ml	Brush Top Can	24	23 lbs. - 10.4 kg	17.18
TF8CA*	1/2 Pint - 237 ml	Brush Top Can (Display Box)	12	13 lbs. - 5.9 kg	18.88
TF16C*	Pint - 473 ml	Brush Top Can	12	22 lbs. - 10.0 kg	28.43
TF32C*	Quart - .95 L	Brush Top Can	12	43 lbs. - 19.5 kg	52.15



\*Bilingual Label: French and English. \*\*Tubes Packed 12 Per Clear Plastic Tub. FlowGuard Gold®, BlazeMaster®, and Corzan® are Registered Trademarks of The Lubrizol Corporation. FlameGuard® is a registered trademark of Spears Manufacturing Company. Pallet Quantities for Thread Sealants: 1/4 Pint = 130 Cases, 1/2 Pint = 80 Cases, 1 Pint = 80 Cases, 1 Quart = 56 Cases, 1 Gallon = 45 Cases.



**THREAD SEALANTS**

**TALON PTFE THREAD COMPOUND** A Triple Lubricating, All Purpose, Non-Seizing, VOC Free, Industrial Grade Thread Sealing Compound that provides Freedom from Leaks™ on all types of metal and plastic threaded connections. **TALON PTFE THREAD COMPOUND** contains Graphite, Ceramic Microspheres, and Virgin PTFE for optimal sealing. Meets International Fuel Gas Code 403.9.3 for Thread Joint Compounds. **MADE IN THE U.S.A.**



STOCK CODE	SIZE	CONTAINER	ITEMS/CASE	CASE WEIGHT	LIST PRICE EACH
TAL4	1/4 Pint - 118 ml	Brush Top Can	24	15 lbs. - 6.8 kg	10.57
TAL8	1/2 Pint - 237 ml	Brush Top Can	24	24 lbs. - 10.9 kg	18.90
TAL8A	1/2 Pint - 237 ml	Brush Top Can (Display Box)	12	13 lbs. - 5.9 kg	20.76
TAL16	Pint - 473 ml	Brush Top Can	12	22 lbs. - 10.0 kg	31.32
TAL32	Quart - .95 L	Brush Top Can	12	42 lbs. - 19.1 kg	57.37
TAL5	5 Gallon - 18.9 L	Pail w/Handle	1	65 lbs. - 29.5 kg	728.52
TAL55	55 Gallon - 208 L	55 Gallon Drum	1	640 lbs. - 290.3 kg	6383.35

**POWER SEAL PLUS** Non-Drying, Arctic Blue PTFE Based Thread Sealing Compound. Specially formulated for the Fire Sprinkler Industry for use on all metal threaded connections, FlowGuard Gold®, BlazeMaster®, and Corzan® CPVC pipe and fittings. Meets Federal Specification TT-S-1732. **MADE IN THE U.S.A.**



POW32	Quart - .95 L	Plastic Container w/Twist Top Lid	12	42 lbs. - 19.1 kg	54.24
POW32B	Quart - .95 L	Brush Top Can	12	44 lbs. - 20.0 kg	54.24
POW5	5 Gallon - 18.9 L	Pail w/Handle	1	73 lbs. - 33.1 kg	692.19
POW55	55 Gallon - 208 L	55 Gallon Drum	1	740 lbs. - 335.7 kg	6099.51

**ANTI-SEIZE**

**TALON COPPER ANTI-SEIZE** Lubricant and Thread Sealant. Lead Free, Non-Seizing, Copper Based conforms to MIL-A-907E Specification. Service Rating to 1800° F (982° C). **MADE IN THE U.S.A.**



CU4	5 oz. - .142 kg	Brush Top Can	24	15 lbs. - 6.8 kg	14.22
CU8	10 oz. - .284 kg	Brush Top Can	24	20 lbs. - 9.1 kg	21.68
CU8A	10 oz. - .284 kg	Brush Top Can (Display Box)	12	10 lbs. - 4.5 kg	23.63
CU16	1 lb. - .454 kg	Brush Top Can	12	19 lbs. - 8.6 kg	29.42
CU32	2-1/2 lbs. - 1.13 kg	Brush Top Can	12	36 lbs. - 16.3 kg	55.35
CU5	50 lbs. - 22.68 kg	Pail w/Handle	1	54 lbs. - 24.5 kg	844.45
CU55	500 lbs. - 226.8 kg	55 Gallon Drum	1	540 lbs. - 244.9 kg	7185.18

**TALON NICKEL ANTI-SEIZE** Lubricant and Thread Sealant. Lead Free, Non-Seizing, Nickel Based exceeds MIL-A-907E Specification. Service Rating to 2600° F (1427° C). **MADE IN THE U.S.A.**



NI8	8 oz. - .227 kg	Brush Top Can	12	10 lbs. - 4.5 kg	38.34
NI16	1 lb. - .454 kg	Brush Top Can	12	19 lbs. - 8.6 kg	63.42

**THREAD SEALANT COMPATIBILITY CHART**

	Acids, concentrated	Acids, dilute	Air, compressed	Alcohols, all	Aliphatic Solvents	Ammonia, gaseous	Ammonia, liquid	Aromatic Solvents	Cautic, concentrated	Cautic, dilute	Chlorinated Solvents	Cutting oils (low aromatic)	Diesel Fuel Oil	Ethylene Glycol (anti-freeze)	Fatty Acids, liquid	Gasohol (unleaded 10% alcohol)	Glycerine	Heating Oils	Helium, gaseous	Hydraulic fluids, water/glycol	Hydraulic Oils	Hydrogen, gaseous	Inert Gases	Jet Fuel (JP3, 4, 5, 6, 8)	Kerosene	Ketones	Liquified Petroleum Gases	Mineral Oils	Natural Gas	Nitrogen, gaseous	Oxygen, gaseous	Petroleum Solvents	Refrigerants	Refrigeration Oil	Soap, liquid	Steam	Vegetable Oils	Water (hot or cold)	
TYTE UNYTE	R	R	R	R	R	R	R	R	R	R	R	R	R	R	R	R	R	R	R	R	R	R	R	R	R	R	R	R	R	R	R	R	R	R	R	R	R	R	R
STEEL UNYTE	R	R	R	R	R	R	R	R	R	R	R	R	R	R	R	R	R	R	R	R	R	R	R	R	R	R	R	R	R	R	R	R	R	R	R	R	R	R	R
T-U TYPE 555	R	R	R	R	R	R	R	R	R	R	R	R	R	R	R	R	R	R	R	R	R	R	R	R	R	R	R	R	R	R	R	R	R	R	R	R	R	R	R
BLUE MAGIC	R	R	R	R	R	R	R	R	R	R	R	R	R	R	R	R	R	R	R	R	R	R	R	R	R	R	R	R	R	R	R	R	R	R	R	R	R	R	R
SELECT-UNYTE	R	R	R	R	R	R	R	R	R	R	R	R	R	R	R	R	R	R	R	R	R	R	R	R	R	R	R	R	R	R	R	R	R	R	R	R	R	R	R
TALON PTFE THREAD COMPOUND	R	R	R	R	R	R	R	R	R	R	R	R	R	R	R	R	R	R	R	R	R	R	R	R	R	R	R	R	R	R	R	R	R	R	R	R	R	R	R
POWER SEAL PLUS	R	R	R	R	R	R	R	R	R	R	R	R	R	R	R	R	R	R	R	R	R	R	R	R	R	R	R	R	R	R	R	R	R	R	R	R	R	R	R
TALON COPPER ANTI-SEIZE	R	R	R	R	R	R	R	R	R	R	R	R	R	R	R	R	R	R	R	R	R	R	R	R	R	R	R	R	R	R	R	R	R	R	R	R	R	R	R
TALON NICKEL ANTI-SEIZE	R	R	R	R	R	R	R	R	R	R	R	R	R	R	R	R	R	R	R	R	R	R	R	R	R	R	R	R	R	R	R	R	R	R	R	R	R	R	R
PTFE TAPES	R	R	R	R	R	R	R	R	R	R	R	R	R	R	R	R	R	R	R	R	R	R	R	R	R	R	R	R	R	R	R	R	R	R	R	R	R	R	R

Pallet Quantities for Thread Sealants: 1/4 Pint = 130 Cases, 1/2 Pint = 80 Cases, 1 Pint = 80 Cases, 1 Quart = 56 Cases, 1 Gallon = 45 Cases. FlowGuard Gold®, BlazeMaster®, and Corzan® are Registered Trademarks of The Lubrizol Corporation. FlameGuard® is a registered trademark of Spears Manufacturing Company.



**THREAD SEALANT TAPE**

**TALON PROFESSIONAL HIGH DENSITY GRAY PTFE TAPE** 3.5 Mil Thick, 0.8g/cm<sup>3</sup> High Density, 100% Elongation. Excellent for natural and LP gas. Meets MIL-T-27730A. Meets International Fuel Gas Code 403.9.3 for Thread Joint Compounds. Packaged in a point of purchase display box.

STOCK CODE	SIZE	CONTAINER	ITEMS/CASE	CASE WEIGHT	LIST PRICE EACH
TL1429	1/2" x 1429" - 1.27 cm x 36.3 m	Plastic Spool	45	6 lbs. - 2.7 kg	4.36
TLW1429	3/4" x 1429" - 1.9 cm x 33.3 m	Plastic Spool	27	6 lbs. - 2.7 kg	5.91
TLX1429	1" x 1429" - 1.9 cm x 33.3 m	Plastic Spool	27	6 lbs. - 2.7 kg	8.55



**TAPE-UNYTE® HIGH DENSITY WHITE PTFE TAPE** PTFE Pipe Joint Compound in Tape Form. Packed on a Spool with Cover. 3.5 Mil Thick, 0.9g/cm<sup>3</sup> High Density. Meets MIL-T-27730A. FDA approved. Meets International Fuel Gas Code 403.9.3 for Thread Joint Compounds. Packaged in a point of purchase display box. **MADE IN THE U.S.A.**

F520	1/4" x 520" - .63 cm x 13.2 m	Plastic Spool	12	1 lb. - 0.5 kg	6.92
T260	1/2" x 260" - 1.27 cm x 6.6 m	Plastic Spool	12	1 lb. - 0.5 kg	5.56
T520	1/2" x 520" - 1.27 cm x 13.2 m	Plastic Spool	12	1 lb. - 0.5 kg	9.09
T1296	1/2" x 1296" - 1.27 cm x 32.9 m	Plastic Spool	12	2 lbs. - 0.9 kg	17.68
W260	3/4" x 260" - 1.9 cm x 6.6 m	Plastic Spool	12	1 lb. - 0.5 kg	8.03
W520	3/4" x 520" - 1.9 cm x 13.2 m	Plastic Spool	12	2 lbs. - 0.9 kg	12.73
X260	1" x 260" - 2.54 cm x 6.6 m	Plastic Spool	12	1 lb. - 0.5 kg	10.12



**YELLOW GAS LINE PTFE TAPE** 4 Mil Thick, 0.9g/cm<sup>3</sup> High Density. Specifically Formulated for use on Natural, LP and Synthetic Gases. UL Approved. Meets or exceeds MIL-T-27730A. Meets International Fuel Gas Code 403.9.3 for Thread Joint Compounds. **MADE IN THE U.S.A.**

GT260	1/2" x 260" - 1.27 cm x 6.6 m	Plastic Spool	144	8 lbs. - 3.6 kg	4.80
GT260A	1/2" x 260" - 1.27 cm x 6.6 m	Plastic Spool	12	1 lb. - 0.5 kg	5.51
GT520	1/2" x 520" - 1.27 cm x 13.2 m	Plastic Spool	144	10 lbs. - 4.5 kg	8.80
GT520A	1/2" x 520" - 1.27 cm x 13.2 m	Plastic Spool	12	1 lb. - 0.5 kg	12.43



**STAINLESS STEEL PTFE TAPE** Gray PTFE Pipe Joint Compound in Tape Form. Formulated for use on all Stainless Steel Fittings. Prevents Galling, Seizing, and Corrosion. 4 Mil Thick, 1.2g/cm<sup>3</sup> Ultra-High Density. Exceeds MIL Spec T-27730A. Meets International Fuel Gas Code 403.9.3 for Thread Joint Compounds. **MADE IN THE U.S.A.**

SST260	1/2" x 260" - 1.27 cm x 6.6 m	Plastic Spool	12	1 lb. - 0.5 kg	7.77
SSTW260	3/4" x 260" - 1.9 cm x 6.6 m	Plastic Spool	12	1 lb. - 0.5 kg	11.51



**QUALITY WHITE IMPORT PTFE TAPE** Pipe Joint Compound in Tape Form. Packed on a Spool with Cover. 3.5 Mil Thick, 0.38g/cm<sup>3</sup> Density. Meets MIL-T-27730A. Meets International Fuel Gas Code 403.9.3 for Thread Joint Compounds.

S260	1/2" x 260" - 1.27 cm x 6.6 m	Plastic Spool	100	3 lbs. - 1.4 kg	0.92
S520	1/2" x 520" - 1.27 cm x 13.2 m	Plastic Spool	100	3 lbs. - 1.4 kg	1.58
S1296	1/2" x 1296" - 1.27 cm x 32.9 m	Plastic Spool	50	3 lbs. - 1.4 kg	4.15
SW260	3/4" x 260" - 1.9 cm x 6.6 m	Plastic Spool	70	3 lbs. - 1.4 kg	1.91
SW520	3/4" x 520" - 1.9 cm x 13.2 m	Plastic Spool	70	3 lbs. - 1.4 kg	2.83
SW1296	3/4" x 1296" - 1.9 cm x 32.9 m	Plastic Spool	150	15 lbs. - 6.8 kg	6.83
SX520	1" x 520" - 2.54 cm x 13.2 m	Plastic Spool	50	3 lbs. - 1.4 kg	4.03



**PUTTY**

**TALON SUPER SOFT STAINLESS PLUMBER'S PUTTY** Never Hardens. Cream Color. Meets Federal Specifications TT-P-1536A. **MADE IN THE U.S.A.**

MT1	14 oz. - .397 kg	Plastic Tub	24	25 lbs. - 11.3 kg	3.65
MT3	3 lbs. - 1.38 kg	Plastic Tub	6	19 lbs. - 8.6 kg	10.29
MT5	5 lbs. - 2.26 kg	Plastic Tub	6	32 lbs. - 14.5 kg	15.32
MT15	15 lbs. - 6.90 kg	Pail w/Handle	4	67 lbs. - 30.4 kg	45.32



**TALON EPOXY FOR PLASTIC** A hand-mixable, fast-setting epoxy putty that forms a durable bond to most major plastic types. After mixing it forms a polymer compound that can be molded, wrapped around, or used to build up and repair just about anything made from rigid or semi-flexible plastic. Packaged in a point of purchase display box. Meets ASTM D-4236. **MADE IN THE U.S.A.**

EPP4	4 oz. - 113.4 g 7" (18 cm) Long Sticks	Plastic Tube (2 Display Cartons)	24	11 lbs. - 5.0 kg	13.96
------	---	-------------------------------------	----	------------------	-------



**TALON EPOXY FOR STEEL** A hand-mixable, steel-reinforced, non-rusting fast-setting epoxy putty that quickly repairs or rebuilds anything made of steel. After mixing it forms a polymer compound that can be molded, wrapped around, build up, patch and repair steel components. Packaged in a point of purchase display box. **MADE IN THE U.S.A.**

EPS4	4 oz. - 113.4 g 7" (18 cm) Long Sticks	Plastic Tube (2 Display Cartons)	24	11 lbs. - 5.0 kg	13.96
------	---	-------------------------------------	----	------------------	-------





**REPAIR CEMENTS & COATINGS**



**BLACK FLASH** Flashing Cement Compound. All Weather. Never Hardens. Meets Federal Specifications SS-C-153. **MADE IN THE U.S.A.**

STOCK CODE	SIZE	CONTAINER	ITEMS/CASE	CASE WEIGHT	LIST PRICE EACH
BFC	1/10 gal - .37 L	Cartridge	12	11 lbs. - 5.0 kg	9.60
BF32	Quart - .95 L	Can	12	33 lbs. - 15.0 kg	19.82
BF1	Gallon - 3.785 L	Can w/Handle	4	40 lbs. - 18.1 kg	46.17



**"BLACK DRAGON" BLACK GILSONITE ASPHALT PAINT** A quick drying, high gloss Asphalt Enamel Paint. Provides excellent corrosion protection for all types of metal surfaces including pipe. Offers one coat coverage with full resistance to water, acids, alkalis, electrolysis, and natural elements. **MADE IN THE U.S.A.**

BD1	Gallon - 3.785 L	Can w/Handle	4	32 lbs. - 14.5 kg	55.14
BD5	5 Gallon - 18.9 L	Pail w/Handle	1	41 lbs. - 18.6 kg	217.37
BD55	55 Gallon - 208 L	Drum	1	550 lbs. - 226.8 kg	2353.77



**TALON DIRECT TO METAL (DTM) ENAMEL** is a premium, industrial grade, alkyd enamel specially formulated for use on all types of metal surfaces. Its special rust-inhibiting formula creates an armor coating against the elements. **TALON DTM ENAMEL** coatings resist mild solvents, oils, mild chemicals and salt water. **MADE IN THE U.S.A.**

DTMBLU1	Gallon - 3.785 L	Blue Boxed	2	19 lbs. - 8.6 kg	76.65
DTMGRN1	Gallon - 3.785 L	Green Boxed	2	19 lbs. - 8.6 kg	76.65
DTMGRY1	Gallon - 3.785 L	Gray Boxed	2	19 lbs. - 8.6 kg	76.65
DTMPUR1	Gallon - 3.785 L	Purple Boxed	2	19 lbs. - 8.6 kg	89.35
DTMRED1	Gallon - 3.785 L	Red Boxed	2	19 lbs. - 8.6 kg	76.65
DTMWHT1	Gallon - 3.785 L	White Boxed	2	19 lbs. - 8.6 kg	76.65
DTMYEL1	Gallon - 3.785 L	Yellow Boxed	2	19 lbs. - 8.6 kg	76.65

**CUTTING OILS**

**TALON LIGHT OIL** Super-Supreme Sulphur Base Cutting and Threading Oil for use with all Pipe Threading Machinery. **MADE IN THE U.S.A.**



WL32	Quart - .95 L	Plastic Jug w/Spout	12	27 lbs. - 12.2 kg	17.91
WL1	Gallon - 3.785 L	Plastic Jug w/Spout	6	48 lbs. - 21.8 kg	42.85
WL5	5 Gallon - 18.9 L	Pail w/Handle	1	39 lbs. - 17.7 kg	209.77
WL55	55 Gallon - 208 L	55 Gallon Drum	1	454 lbs. - 205.9 kg	2037.49

**TALON DARK OIL** Super-Supreme Sulphur Base Cutting and Threading Oil for use with all Pipe Threading Machinery. **MADE IN THE U.S.A.**



WD32	Quart - .95 L	Plastic Jug w/Spout	12	27 lbs. - 12.2 kg	17.91
WD1	Gallon - 3.785 L	Plastic Jug w/Spout	6	48 lbs. - 21.8 kg	42.85
WD5	5 Gallon - 18.9 L	Pail w/Handle	1	39 lbs. - 17.7 kg	209.77
WD55	55 Gallon - 208 L	55 Gallon Drum	1	454 lbs. - 205.9 kg	2037.49

**CAULKING GUNS**

**STANDARD RATCHET CAULKING GUN** This standard ratchet type caulking gun is recommended for MEDIUM and LIGHT consistency caulks, sealants and adhesives. The sturdy steel construction will ensure long lasting use.



#48	Standard	Boxed	6	7 lbs. - 3.2 kg	10.76
-----	----------	-------	---	-----------------	-------

**PROFESSIONAL RATCHET CAULKING GUN** Superior smooth rod frame caulkers are uniquely designed for professionals to develop a powerful thrust ratio, making the extrusion of stiff caulks and sealants easy and comfortable. Gun features three extra built-in tool functions: seal puncture tool, spout cutter and ladder hook. **MADE IN THE U.S.A.**



#56	Standard	Boxed	6	9 lbs. - 4.1 kg	20.57
-----	----------	-------	---	-----------------	-------





**DAP® KWIK SEAL® KITCHEN & BATH ADHESIVE CAULK**

**DAP® KWIK SEAL®** Bonds like a glue and seals like a caulk. Provides a durable, 100% waterproof seal. Cured caulk is mold and mildew resistant. Applies easily and tools smoothly. Excellent adhesion. Paintable. Low odor and easy water clean-up.



STOCK CODE	SIZE	CONTAINER	ITEMS/CASE	CASE WEIGHT	LIST PRICE EACH
<b>WHITE</b>					
18001	5.5 fl. oz. - 163 ml	Plastic Tube	12	8 lbs. - 3.6 kg	5.46
18032	10 fl. oz. - 296 ml	Cartridge	12	15 lbs. - 6.8 kg	9.58
<b>CLEAR</b>					
18008	5.5 fl. oz. - 163 ml	Plastic Tube	12	8 lbs. - 3.6 kg	5.56
<b>ALMOND</b>					
18013	5.5 fl. oz. - 163 ml	Plastic Tube	12	8 lbs. - 3.6 kg	5.56

**DAP® PHENOSEAL® VINYL ADHESIVE ALL PURPOSE CAULK**

**DAP® PHENOSEAL® VINYL ADHESIVE CAULK** A versatile all-purpose caulk, Phenoseal® Vinyl Adhesive Caulk is perfect for almost any job. It truly does it all - BONDS, CAULKS and SEALS. As an adhesive, it creates a strong bond; as a caulk, it contracts and expands to seal joints up to 1/4", as a sealant, it keeps water and air from penetrating cracks and seams preventing energy loss. This fast-drying interior/exterior formula cleans easily with soap and water. Cured caulk is mold and mildew resistant and can be painted with latex and oil-based paint.



<b>WHITE</b>					
00005	10 fl. oz. - 296 ml	Cartridge	12	10 lbs. - 4.5 kg	9.47

**DAP® KITCHEN & BATH 100% SILICONE RUBBER SEALANT**

**DAP® KITCHEN & BATH 100% SILICONE RUBBER SEALANT** Provides excellent durability, flexibility and adhesion for a long-lasting, 100% waterproof seal. Cured sealant is mold and mildew resistant. Lifetime Guarantee from DAP®.



<b>CLEAR</b>					
00751	2.8 fl. oz. - 83 ml	Plastic Tube	6	2 lbs. - 1.0 kg	9.37

**DAP® HVAC PROFESSIONAL 100% RTV SILICONE**

**DAP® HVAC PROFESSIONAL 100% RTV SILICONE** A high-performance sealant designed especially for HVAC applications. It provides a long-lasting, weather-resistant seal with supreme adhesion, flexibility, and durability. It adheres to most common building materials and remains flexible from -40 to 475°F. Meets Fed. Spec. TT-S-00230 C Class A, TT-S-001543 A Class A, ASTM C920, Class 25, FDA Reg. No. 21 CFR 177, 2600 when fully cured. Safe for incidental food contact - NSF Certified.



<b>WHITE</b>					
08010	10 fl. oz. - 296 ml	Cartridge	12	8 lbs. - 3.6 kg	9.75
<b>CLEAR</b>					
08011	10 fl. oz. - 296 ml	Cartridge	12	8 lbs. - 3.6 kg	9.75
<b>HIGH TEMP RED</b>					
08013	10 fl. oz. - 296 ml	Cartridge	12	8 lbs. - 3.6 kg	12.59

**DAP® TOUCH 'N SEAL QUICK CURE HIGH YIELD POLYURETHANE FOAM**

**DAP® TOUCH 'N SEAL QUICK CURE HIGH YIELD POLYURETHANE FOAM** A high performance, single component, moisture curing, Class 1 fire retardant, expanding polyurethane sealant. Use Quick Cure HY when high expansion is needed to fill and seal larger gaps and cracks.



00057	11 fl. oz. - 325 ml	Aerosol Can	12	13 lbs. - 5.9 kg	15.14
-------	---------------------	-------------	----	------------------	-------

**DAP® TOUCH 'N FOAM® FIREBREAK FLAME RESISTANT SEALANT**

**DAP® TOUCH 'N FOAM® FIREBREAK FLAME RESISTANT SEALANT** is an easy-to-use fireblock\* foam sealant that's ideal for small contractor jobs. Independent testing confirms that FireBreak resists flaming twice as long as the competition and prohibits oxygen flow into service penetrations where fire may quickly spread. Using FireBreak in these penetrations slows the fire taking it longer to move to adjoining rooms, giving one valuable time to get to safety. FireBreak is bright orange and can be easily identified as an approved fireblock penetration sealant. Space connections in soffits and drop ceilings. Partitions and stud walls at ceilings and floors. Top and bottom of stair stringers. Through-penetration (electrical, plumbing, etc.). Meets ASTM E84/UL 723; Class A Fire Rated. Only approved fireblock to pass the UL 94 V-0 Burn Test. Meets ASTM E814 (modified) and UL 1715. \*NOT A FIRESTOP. Approved fireblock formula (ICC-ES ESR-1926).



10012	12 fl. oz. - 355 ml	Aerosol Can	12	13 lbs. - 5.9 kg	23.43
-------	---------------------	-------------	----	------------------	-------

**ABRASIVE CLOTHS**

**BROWN SAND CLOTH 120J Waterproof, Brown Abrasive Cloth for Cleaning Copper Pipe.**



STOCK CODE	SIZE	CONTAINER	ITEMS/CASE	CASE WEIGHT	LIST PRICE EACH
JAO5	1-1/2" x 5 yd. - 3.81 cm x 4.54 m	Boxed	50	15 lbs. - 6.8 kg	6.12
JAO5A	1-1/2" x 5 yd. - 3.81 cm x 4.54 m	Boxed	24	8 lbs. - 3.6 kg	6.64
JAO10	1-1/2" x 10 yd. - 3.81 cm x 9.08 m	Boxed	50	26 lbs. - 11.8 kg	9.94
JAO10A	1-1/2" x 10 yd. - 3.81 cm x 9.08 m	Boxed	24	13 lbs. - 5.9 kg	10.88
JAO25	1-1/2" x 25 yd. - 3.81 cm x 22.7 m	Boxed	20	26 lbs. - 11.8 kg	21.16

**BLUE SAND CLOTH 120J Waterproof, Blue Abrasive Cloth for Cleaning Copper Pipe. 100% Jean Cloth Backing.**



WP5	1-1/2" x 5 yd. - 3.81 cm x 4.54 m	Boxed	50	14 lbs. - 6.4 kg	6.59
WP5A	1-1/2" x 5 yd. - 3.81 cm x 4.54 m	Boxed	24	7 lbs. - 3.2 kg	7.35
WP10	1-1/2" x 10 yd. - 3.81 cm x 9.08 m	Boxed	50	24 lbs. - 10.9 kg	11.35
WP10A	1-1/2" x 10 yd. - 3.81 cm x 9.08 m	Boxed	24	14 lbs. - 6.4 kg	12.48
WP25	1-1/2" x 25 yd. - 3.81 cm x 22.7 m	Boxed	20	22 lbs. - 10.0 kg	24.38
WP25A	1-1/2" x 25 yd. - 3.81 cm x 22.7 m	Boxed	12	16 lbs. - 7.3 kg	26.71

**OPEN MESH CLOTH Nylon Open Mesh Abrasive Cloth for Cleaning Copper Pipe. Waterproof and Reusable.**



OM5	1-1/2" x 5 yd. - 3.81 cm x 4.54 m	Boxed	50	14 lbs. - 6.4 kg	13.28
OM5A	1-1/2" x 5 yd. - 3.81 cm x 4.54 m	Boxed	24	7 lbs. - 3.2 kg	14.66
OM10	1-1/2" x 10 yd. - 3.81 cm x 9.08 m	Boxed	50	23 lbs. - 10.4 kg	21.84
OM10A	1-1/2" x 10 yd. - 3.81 cm x 9.08 m	Boxed	24	11 lbs. - 5.0 kg	24.22
OM25	1-1/2" x 25 yd. - 3.81 cm x 22.7 m	Boxed	20	21 lbs. - 9.5 kg	52.36
OM25A	1-1/2" x 25 yd. - 3.81 cm x 22.7 m	Boxed	12	14 lbs. - 6.4 kg	57.49

**FITTING BRUSHES**

**WIRE HANDLE PLUMBING COPPER FITTING BRUSHES** High Carbon Steel, Reusable Copper Cleaning Brushes with Wire Handle. Sizes I.D. Nominal. **MADE IN THE U.S.A.**

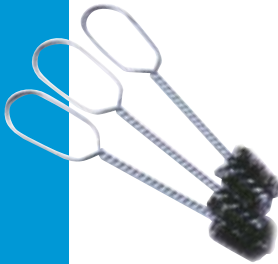

CF18	1/8" ID - .32 cm ID	Boxed	12	1 lb. - 0.5 kg	3.18
CF25	1/4" ID - .63 cm ID	Boxed	12	1 lb. - 0.5 kg	2.97
CF38	3/8" ID - .95 cm ID	Boxed	12	1 lb. - 0.5 kg	2.97
CF5	1/2" ID - 1.27 cm ID	Boxed	12	1 lb. - 0.5 kg	3.09
CF58	5/8" ID - 1.58 cm ID	Boxed	12	1 lb. - 0.5 kg	3.18
CF75	3/4" ID - 1.91 cm ID	Boxed	12	1 lb. - 0.5 kg	3.18
CF1	1" ID - 2.54 cm ID	Boxed	12	1 lb. - 0.5 kg	3.72
CF125	1-1/4" ID - 3.18 cm ID	Boxed	6	1 lb. - 0.5 kg	4.12
CF15	1-1/2" ID - 3.81 cm ID	Boxed	6	1 lb. - 0.5 kg	4.19
CF2	2" ID - 5.08 cm ID	Boxed	6	1 lb. - 0.5 kg	4.66
CF250	2-1/2" ID - 6.35 cm ID	Boxed	6	1 lb. - 0.5 kg	6.29

**SOLID HANDLE PLUMBING COPPER FITTING BRUSHES** High Carbon Steel, Reusable Copper Cleaning Brushes with Solid Plastic Handle. Cleans fast! Sizes I.D. Nominal. **MADE IN THE U.S.A.**



CP18	1/8" ID - .32 cm ID	Boxed	12	1 lb. - 0.5 kg	4.59
CP25	1/4" ID - .63 cm ID	Boxed	12	1 lb. - 0.5 kg	4.59
CP38	3/8" ID - .95 cm ID	Boxed	12	1 lb. - 0.5 kg	4.05
CP5	1/2" ID - 1.27 cm ID	Boxed	12	1 lb. - 0.5 kg	4.05
CP58	5/8" ID - 1.58 cm ID	Boxed	12	1 lb. - 0.5 kg	4.19
CP75	3/4" ID - 1.91 cm ID	Boxed	12	1 lb. - 0.5 kg	4.19
CP1	1" ID - 2.54 cm ID	Boxed	12	1 lb. - 0.5 kg	5.28
CP125	1-1/4" ID - 3.18 cm ID	Boxed	6	1 lb. - 0.5 kg	5.65
CP15	1-1/2" ID - 3.81 cm ID	Boxed	6	1 lb. - 0.5 kg	6.40
CP2	2" ID - 5.08 cm ID	Boxed	6	1 lb. - 0.5 kg	7.25



**FLUX & GREASE**

**TALON SOLDER FLUX PASTE** Self-Cleaning, Noncorrosive, Lead Free. Specially formulated for use with 95/5, 60/40, 50/50, 40/60 and Lead Free Solders on Copper, Galvanized Iron, Tin, Mild Steel, Terneplate, Zinc, Silver, Nickel and Sheet Lead. **Not recommended for use on aluminum.**

STOCK CODE	SIZE	CONTAINER	ITEMS/CASE	CASE WEIGHT	LIST PRICE EACH
FT2	2 oz. - 57 g	Plastic Jar	144	26 lbs. - 11.8 kg	3.44
FT2A	2 oz. - 57 g	Plastic Jar	36	7 lbs. - 3.2 kg	3.65
FT4	4 oz. - 113.4 g	Plastic Jar	24	8 lbs. - 3.6 kg	5.58
FT8BT	8 oz. - 226.8 g	Plastic Jar w/Brush	24	17 lbs. - 7.7 kg	9.04
FT1	1 lb. - 454 g	Plastic Jar	24	29 lbs. - 13.2 kg	14.31



**TALON WATER SOLUBLE PASTE FLUX** Specially Formulated, Creamy, White, Water Flushable Paste Flux that holds its shape and will not slump until being heated above 122°F (50°C). Suitable for use on all types of tin solder and their alloys. Meets ASTM B-813. **MADE IN THE U.S.A.**

TWF2	2 oz. - 57 g	Plastic Jar	36	8 lbs. - 3.6 kg	5.09
TWF4	4 oz. - 113.4 g	Plastic Jar	24	9 lbs. - 4.1 kg	9.89
TWF8BT	8 oz. - 226.8 g	Plastic Jar w/Brush	24	17 lbs. - 7.7 kg	14.19
TWF1	1 lb. - 454 g	Plastic Jar	24	31 lbs. - 14.1 kg	23.82



**E-Z TURN FAUCET & VALVE HEAT PROOF GREASE** Waterproof, High Temperature up to 350°F (176°C) for Lubricating Valve Stems of Faucets, Valves, Ballcocks, Plungers, Packings and Washers. Prevents sticking and rust. **MADE IN THE U.S.A.**

HPG2	2 oz. - 56.7 g	Plastic Container	24	5 lbs. - 2.3 kg	3.79
HPG2C*	2 oz. - 56.7 g	Plastic Container	24	5 lbs. - 2.3 kg	3.79



**MULTI-PURPOSE SILICONE GREASE** Moisture resistant, non-curing paste. Wide temperature range from -70°F (57°C) to 400°F (204°C). Excellent for lubricating valve stems of faucets, valves, ballcocks, plungers, packings, washers, food equipment, hydrants, backflows, and O-rings. Also recommended for waterproofing electrical and mechanical devices. Made from Food Grade Silicone. Meets: FDA-CFR-21-178.3570 and SAE-AS-8660. **MADE IN THE U.S.A.**

SG2	2 oz. - 56.7 g	Plastic Container	24	5 lbs. - 2.3 kg	7.02
-----	----------------	-------------------	----	-----------------	------



**PIPE GASKET LUBRICANTS**

**BLUE LUBE POLYMER-BASED PIPE GASKET LUBE** A water-soluble lubricant for all metal or plastic gasketed pipe including Victaulic\*\* type fittings. Works on wet or dry surfaces. Safe for Potable Water Systems. Odorless and Cleans up Easily. Nontoxic, Noncorrosive, Nonflammable. **MADE IN THE U.S.A.**

GLP4	1/4 Pint - 118 ml	Plastic Jar	24	8 lbs. - 3.6 kg	3.02
GLP16	Pint - 473 ml	Plastic Container	24	30 lbs. - 13.6 kg	6.99
GLP32	Quart - .95 L	Plastic Container w/Twist Top Lid	12	28 lbs. - 12.7 kg	10.50
GLP1	Gallon - 3.785 L	Pail w/Handle	4	37 lbs. - 16.8 kg	36.08
GLP5	5 Gallon - 18.9 L	Pail w/Handle	1	45 lbs. - 20.4 kg	152.40
GLP55	55 Gallon - 208 L	55 Gallon Drum	1	500 lbs. - 226.8 kg	1625.68



**PIPE SLIME PIPE GASKET LUBE** An Emulsified Polymer Based Lubricant that is specially formulated to prevent turbidity, taste, and/or odor problems in new water main installations. Great for use with mechanical couplings. All weather formula is excellent for low-temperature applications. Temperature Range Use: 0°F (-18°C) to 150°F (66°C). **MADE IN THE U.S.A.**

SLIME4	1/4 Pint - 118 ml	Plastic Jar	24	8 lbs. - 3.6 kg	4.12
SLIME16	Pint - 473 ml	Plastic Container	24	30 lbs. - 13.6 kg	6.62
SLIME32	Quart - .95 L	Plastic Container w/Twist Top Lid	12	28 lbs. - 12.7 kg	12.31
SLIME1	Gallon - 3.785 L	Pail w/Handle	4	37 lbs. - 16.8 kg	42.97
SLIME5	5 Gallon - 18.9 L	Pail w/Handle	1	45 lbs. - 20.4 kg	183.49
SLIME55	55 Gallon - 208 L	55 Gallon Drum	1	500 lbs. - 226.8 kg	1859.28

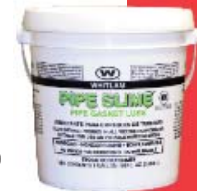

**QUICK SLIP PLUS VEGETABLE OIL-BASED PIPE JOINT LUBRICANT** A paste lubricant for all metal or plastic gasketed pipe including Victaulic\*\* type fittings. Works on Wet or Dry Surfaces. Safe for Potable Water Systems. Nontoxic, Noncorrosive, Nonflammable. **MADE IN THE U.S.A.**

QS32	Quart - .95 L	Plastic Container w/Twist Top Lid	12	30 lbs. - 13.6 kg	13.82
QS1	Gallon - 3.785 L	Pail w/Handle	4	34 lbs. - 15.4 kg	45.09
QS5	5 Gallon - 18.9 L	Pail w/Handle	1	46 lbs. - 20.9 kg	218.31
QS55	55 Gallon - 208 L	55 Gallon Drum	1	480 lbs. - 217.7 kg	2324.66

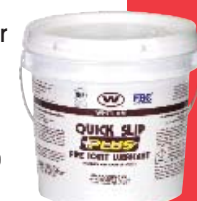

\*Bilingual Label: French and English. \*\*Trademark of Victaulic Company.  
 Pallet Quantities for Blue Lube Paste: 1 Pint = 40 Cases, 1 Quart = 40 Cases, 1 Gallon = 45 Cases, 5 Gallon = 32 Pails.  
 Pallet Quantities for Pipe Slime and Quick Slip Plus: 1 Pint = 40 Cases, 1 Quart = 40 Cases, 1 Gallon = 45 Cases, 5 Gallon = 32 Pails.



**SYSTEM DESCALER**

**FLOW-AIDE SYSTEM DESCALER** Quickly dissolves water scale, lime, rust and other water formed deposits, restoring efficiency to most appliances. Noncorrosive, Nontoxic, Fully Biodegradable, Safe to Handle, Zero VOC. Certified to NSF/ANSI 60 for use as a cleaner in potable water systems. **MADE IN THE U.S.A.**



STOCK CODE	SIZE	CONTAINER	ITEMS/CASE	CASE WEIGHT	LIST PRICE EACH
FLOW32	Quart - .95 L	Plastic Jug w/Spout	12	30 lbs. - 13.6 kg	24.00
FLOW1	Gallon - 3.785 L	Plastic Jug w/Spout	6	57 lbs. - 25.9 kg	71.77
FLOW5	5 Gallon - 18.9 L	Pail w/Handle	1	48 lbs. - 21.8 kg	269.60
FLOW55	55 Gallon - 208 L	55 Gallon Drum	1	518 lbs. - 235.0 kg	2722.55
FLOW275	275 Gallon - 1041 L	Tote	1	2603 lbs. - 1180.7 kg	CALL FOR PRICE
FLOW32C*	Quart - .95 L	Plastic Jug w/Spout	12	30 lbs. - 13.6 kg	24.00
FLOW1C*	Gallon - 3.785 L	Plastic Jug w/Spout	6	57 lbs. - 25.9 kg	71.77

**FLOW-AIDE SYSTEM DESCALER KIT**

Whitlam's complete descaler kit includes: 1 - 3.5 Gallon Bucket, 1 - 725 GPH Pump, 2 - Rubber Hoses, 1 - Quart FLOW-AIDE (FLOW32)



FLOW-KIT	3.5 Gallon Bucket	1	13 lbs. - 5.9 kg	262.26
FLOW-DISPLAY†	Contains: 16 each FLOW32, 6 each FLOW-KIT	1	115 lbs. - 52.2 kg	1957.07
FLOW-KITC*	3.5 Gallon Bucket	1	13 lbs. - 5.9 kg	262.26
FLOW-DISPLAYC*†	Contains: 16 each FLOW32C*, 6 each FLOW-KITC*	1	115 lbs. - 52.2 kg	1957.07



**FLOW-AIDE COMMERCIAL GRADE SYSTEM DESCALER KIT**

Whitlam's complete descaler kit includes: 1 - 5 Gallon Bucket, 1 - 1150 GPH Pump, 2 - Rubber Hoses, 1 - Gallon FLOW-AIDE (FLOW1)



FLOW-COM5	5 Gallon Bucket	1	22 lbs. - 10.0 kg	398.24
FLOW-COMD†	Contains: 12 each FLOW32, 6 each FLOW1, 3 each FLOW-KIT, 2 each FLOW-COM5	1	173 lbs. - 78.5 kg	2238.55



**REPLACEMENT PUMPS FOR FLOW-AIDE SYSTEM DESCALER KITS** Submersible, magnetic drive utility pump with 15 foot power cord.

#EZ-725	725 GPH	Boxed	1	4 lbs. - 1.8 kg	216.71
#EZ-1150	1150 GPH	Boxed	1	7 lbs. - 3.2 kg	276.08



**REPLACEMENT HOSES FOR FLOW-AIDE SYSTEM DESCALER KIT** Rubber hoses with brass connectors. **MADE IN THE U.S.A.**

#500	60" - 1.5 m Male and Female Ends	Boxed	1	1 lb. - .5 kg	13.44
#501	60" - 1.5 m Two Female Ends	Boxed	1	1 lb. - .5 kg	13.93



**LIQUID DRAIN TRAP PRIMER AND WATERLESS URINAL TRAP SEALANT**

**TALON LIQUID DRAIN TRAP PRIMER** Eliminates drain odors. For use in shower drain traps, outdoor drain traps, basement drains, water heater drains, maintenance areas, floor traps, mop sink traps, residential bathrooms, kitchen sink traps, laundry room traps and in HVAC condensation drain traps. Long lasting and biodegradable. **MADE IN THE U.S.A.**

TDTP32	Quart - .95 L	Plastic Jug w/Spout	12	27 lbs. - 12.2 kg	33.69
TDTP1	Gallon - 3.785 L	Plastic Jug w/Spout	6	48 lbs. - 21.8 kg	101.06

**TALON WATERLESS URINAL TRAP SEALANT** Eliminates urinal odor problems. Ready-to-use trap liquid sealant for use in waterless urinals. **MADE IN THE U.S.A.**

TUTS32	Quart - .95 L	Plastic Jug w/Spout	12	27 lbs. - 12.2 kg	33.69
TUTS1	Gallon - 3.785 L	Plastic Jug w/Spout	6	48 lbs. - 21.8 kg	101.06



\*Bilingual Label: French and English.  
†Displays ship assembled



**DRAIN OPENERS & DRAIN CLEANERS**

**TALON DRAIN OPENER\*** Non-acid flake drain opener for clearing grease, hair, soap, oils, and other organic matter from drains. Hot water activated. Works in less than 60 seconds. Will not harm chrome, polished brass or plastic. Safe for septic tanks. **MADE IN THE U.S.A.**  
**For professional use only. Not for retail sale.**



STOCK CODE	SIZE	CONTAINER	ITEMS/CASE	CASE WEIGHT	LIST PRICE EACH
TDC1	1 lb. - 454 g	Plastic Container**	24	33 lbs. - 15.0 kg	12.85
TDC2	2 lbs. - 907 g	Plastic Container**	12	32 lbs. - 14.5 kg	24.08

**NOW! H<sub>2</sub>SO<sub>4</sub> DRAIN PIPE OPENER\*** A powerful sulfuric acid. This product is ideal for dissolving organic matter, melting heavy grease deposits and opening clogged drains. **MADE IN THE U.S.A.**  
**Do not use in toilets. For professional use only. Not for retail sale.**



NW32	Quart - .95 L	Plastic Jug w/Spout**	12	50 lbs. - 22.7 kg	18.62
NW64	1/2 Gallon - 1.89 L	Plastic Jug w/Spout**	6	47 lbs. - 21.3 kg	32.05

**QUICK! HCL - RUST, LIME, CONCRETE and SCALE REMOVER\*** Removes rust, lime, concrete and scale from air conditioning equipment, refrigerator drains, water piping, boilers, water pump condensers, water sealed blowers, etc. Excellent for removing uretic salts in urinals. **MADE IN THE U.S.A.**  
**For professional use only. Not for retail sale.**

QK32	Quart - .95 L	Plastic Jug w/Spout**	12	34 lbs. - 15.4 kg	17.53
QK1	Gallon - 3.785 L	Plastic Jug w/Spout**	4	43 lbs. - 19.5 kg	48.01

**TALON URINAL CLEANER AND DESCALER\*** Dissolves and removes uric acid deposits from urinal drains and traps. Designed to keep urinals open and free flowing, eliminating bothersome uric acid odors. **MADE IN THE U.S.A.**



TUBC32	Quart - .95 L	Plastic Bottle	12	34 lbs. - 15.4 kg	25.65
TUBC1	Gallon - 3.785 L	Plastic Jug	4	43 lbs. - 19.5 kg	89.77

**HAND CLEANERS**

**TALON 9" x 12" HAND CLEANING TOWELS** 70 Count Roll of Wiping Towels for Removal of Dirt, Paint and Adhesives. Works great on removing: plumbing cement, urethane foam, pond dye, epoxy, silicone sealant, acrylic spray paint, varnish, rubber cement and latex paint.



TFB80	9" x 12" 22.86 cm x 30.48 cm	Plastic Dispenser	6	15 lbs. - 6.8 kg	35.32
TFB80D	42-3/4" high x 11-1/4" wide x 10-3/4" deep 108.6 cm high x 28.6 cm wide x 27.3 cm deep	Plastic Dispenser (Display Tower)	20	50 lbs. - 22.7 kg	724.15

**TALON HAND CLEANER** Citrus Lotion Hand Cleaner with Lanolin and Walnut Scrubbers. Industrial Strength. Removes Grease, Grime and Dirt Easily. **MADE IN THE U.S.A.**

THC4	4 fl. oz. - 118 ml	Plastic Container	24	8 lbs. - 3.6 kg	3.84
THC16	16 fl. oz. - 473 ml	Plastic Container (Display Box)	12	16 lbs. - 7.3 kg	11.16
THC1	Gallon - 3.785 L	Plastic Jug w/Spout	6	58 lbs. - 26.3 kg	43.02
THC1D		Dispenser for THC1 (Pumper)	1	1 lb. - 0.5 kg	11.06



**GLUE-WASH PUMICE HAND CLEANER** Lanolized Hand Cleaner. Safely Removes PVC, ABS, CPVC, Foam, Vinyl Cements, Silicone Sealants and Paints from Skin. **MADE IN THE U.S.A.**

GWP4	4 fl. oz. - 118 ml	Plastic Container	24	9 lbs. - 4.1 kg	4.64
GWP16	16 fl. oz. - 473 ml	Plastic Container (Display Box)	12	16 lbs. - 7.3 kg	13.25

\*D.O.T. Classified Shipping Items. See Page 39. \*\*Childproof Caps.

**FLANGE BOLTS, HEX NUTS & WASHERS**

**SOLID BRASS TOILET FLANGE BOLT SETS (POLY BAGGED)** Each Bag Contains 2 Each Solid Brass Flange Bolts, Zinc Plated Open End Acorn Hex Nuts and Plated Steel Round Washers.

STOCK CODE	SIZE	CONTAINER	ITEMS/CASE	CASE WEIGHT	LIST PRICE EACH
<b>FB101</b>	1/4" x 2-1/4" - .6 cm x 5.7 cm	Bagged	50	5 lbs. - 2.3 kg	2.62
<b>FB102</b>	5/16" x 2-1/4" - .8 cm x 5.7 cm	Bagged	50	8 lbs. - 3.6 kg	3.37
<b>FB103</b>	1/4" x 3-1/2" - .6 cm x 8.9 cm	Bagged	50	7 lbs. - 3.2 kg	3.56

**SOLID BRASS TOILET FLANGE BOLT SETS (POLY BAGGED)** Each Bag Contains 2 Each Solid Brass Flange Bolts, 4 Each Zinc Plated Open End Acorn Hex Nuts and 4 Each Plated Steel Round Washers.

<b>FB101-D*</b>	1/4" x 2-1/4" - .6 cm x 5.7 cm	Bagged	50	7 lbs. - 3.2 kg	2.88
<b>FB102-D*</b>	5/16" x 2-1/4" - .8 cm x 5.7 cm	Bagged	50	10 lbs. - 4.5 kg	3.77
<b>FB103-D*</b>	1/4" x 3-1/2" - .6 cm x 8.9 cm	Bagged	50	9 lbs. - 4.1 kg	3.93

**SOLID BRASS TOILET FLANGE BOLT SETS (POLY BAGGED)** Each Bag Contains 2 Each Solid Brass Flange Bolts, Zinc Plated Open End Acorn Hex Nuts, Plated Steel Round Washers and Plastic Retainer Washers.

<b>FB101-R*</b>	1/4" x 2-1/4" - .6 cm x 5.7 cm	Bagged	50	7 lbs. - 3.2 kg	2.88
<b>FB102-R*</b>	5/16" x 2-1/4" - .8 cm x 5.7 cm	Bagged	50	10 lbs. - 4.5 kg	3.77
<b>FB103-R*</b>	1/4" x 3-1/2" - .6 cm x 8.9 cm	Bagged	50	9 lbs. - 4.1 kg	3.93

**BRASS PLATED STEEL TOILET FLANGE BOLT SETS (POLY BAGGED)** Each Bag Contains 2 Each Brass Plated Steel Flange Bolts, Plated Steel Open End Acorn Hex Nuts and Plated Steel Round Washers.

<b>FB300</b>	1/4" x 2-1/4" - .6 cm x 5.7 cm	Bagged	50	6 lbs. - 2.7 kg	1.51
<b>FB301</b>	5/16" x 2-1/4" - .8 cm x 5.7 cm	Bagged	50	7 lbs. - 3.2 kg	2.03

**BRASS PLATED STEEL TOILET FLANGE BOLT SETS (POLY BAGGED)** Each Bag Contains 2 Each Brass Plated Steel Flange Bolts, 4 Each Plated Steel Open End Acorn Hex Nuts and 4 Each Plated Steel Round Washers.

<b>FB300-D*</b>	1/4" x 2-1/4" - .6 cm x 5.7 cm	Bagged	50	8 lbs. - 3.6 kg	1.87
<b>FB301-D*</b>	5/16" x 2-1/4" - .8 cm x 5.7 cm	Bagged	50	9 lbs. - 4.1 kg	2.57

**BRASS PLATED STEEL TOILET FLANGE BOLT SETS (POLY BAGGED)** Each Bag Contains 2 Each Brass Plated Steel Flange Bolts, Plated Steel Open End Acorn Hex Nuts, Plated Steel Round Washers and Plastic Retainer Washers.

<b>FB300-R*</b>	1/4" x 2-1/4" - .6 cm x 5.7 cm	Bagged	50	8 lbs. - 3.6 kg	1.87
<b>FB301-R*</b>	5/16" x 2-1/4" - .8 cm x 5.7 cm	Bagged	50	9 lbs. - 4.1 kg	2.57

**BREAK-A-WAY SOLID BRASS TOILET FLANGE BOLT SETS (POLY BAGGED)** Each Bag Contains 2 Each Break-A-Way Solid Brass Flange Bolts, Zinc Plated Steel Open End Acorn Hex Nuts, Plated Steel Round Washers and Plated Steel Oval Washers.

<b>BA100</b>	1/4" x 2-1/4" - .6 cm x 5.7 cm	Bagged	50	6 lbs. - 2.7 kg	3.49
<b>BA101</b>	5/16" x 2-1/4" - .8 cm x 5.7 cm	Bagged	50	9 lbs. - 4.1 kg	4.66

**BREAK-A-WAY SOLID BRASS TOILET FLANGE BOLT SETS (POLY BAGGED)** Each Bag Contains 2 Each Break-A-Way Solid Brass Flange Bolts, 2 Each Zinc Plated Steel Open End Acorn Hex Nuts, 4 Each Plated Steel Round Washers and 4 Each Plated Steel Oval Washers.

<b>BA100-D*</b>	1/4" x 2-1/4" - .6 cm x 5.7 cm	Bagged	50	8 lbs. - 3.6 kg	4.12
<b>BA101-D*</b>	5/16" x 2-1/4" - .8 cm x 5.7 cm	Bagged	50	11 lbs. - 5.0 kg	4.73

**BREAK-A-WAY SOLID BRASS TOILET FLANGE BOLT SETS (POLY BAGGED)** Each Bag Contains 2 Each Break-A-Way Solid Brass Flange Bolts, Zinc Plated Steel Open End Acorn Hex Nuts, Plated Steel Round Washers, Plated Steel Oval Washers and Plastic Retainer Washers.

<b>BA100-R*</b>	1/4" x 2-1/4" - .6 cm x 5.7 cm	Bagged	50	8 lbs. - 3.6 kg	4.12
<b>BA101-R*</b>	5/16" x 2-1/4" - .8 cm x 5.7 cm	Bagged	50	11 lbs. - 5.0 kg	4.73

**BREAK-A-WAY SOLID BRASS TOILET FLANGE BOLT SETS WITH BRASS CAPTIVE ROUND WASHER (POLY BAGGED)** Each Bag Contains 2 Each Solid Brass Break-A-Way Flange Bolts with Brass Captive Round Washer, Solid Brass Round Washers and 9/16" (1.45 cm) Solid Brass Open End Acorn Hex Nuts. **MADE IN THE U.S.A.**

<b>BA400</b>	1/4" x 2-1/4" - .6 cm x 5.7 cm	Bagged	50	6 lbs. - 2.7 kg	4.55
<b>BA401</b>	5/16" x 2-1/4" - .8 cm x 5.7 cm	Bagged	50	9 lbs. - 4.1 kg	5.82



**WAX RINGS & WAX RINGS WITH BOLTS**

**REGULAR WAX RINGS** Full size wax ring.

STOCK CODE	SIZE	CONTAINER	ITEMS/CASE	CASE WEIGHT	LIST PRICE EACH
<b>S1WR</b>	Regular Wax Ring	Boxed	48	23 lbs. - 10.4 kg	1.68

Fits 3" (7.62 cm) and 4" (10.16 cm) drains. Meets U.S. Federal Specification TT-P-1536A. Fits All Standard Drains.



**FLANGED WAX RINGS** Extra long flange is excellent for built-up floors.

<b>S1WS</b>	Flanged Wax Ring	Boxed	24	15 lbs. - 6.8 kg	1.91
-------------	------------------	-------	----	------------------	------

Fits 3" (7.62 cm) and 4" (10.16 cm) drains. Meets U.S. Federal Specification TT-P-1536A. Fits All Standard Drains.



**FLEX-O-SEAL JUMBO REGULAR WAX RING** Extra thick wax ring.

<b>FOS1RJ</b>	Jumbo Regular Wax Ring	Boxed	24	14 lbs. - 6.4 kg	3.79
---------------	------------------------	-------	----	------------------	------

Jumbo Bowl Setting Wax Rings fit 3" (7.62 cm) and 4" (10.16 cm) drains. 40% more wax than regular ring. Saves labor time on installations and makes for a more positive seal.



**FLEX-O-SEAL JUMBO FLANGED WAX RING** Extra thick wax with extra long flange.

<b>FOS1SJ</b>	Jumbo Flanged Wax Ring	Boxed	24	12 lbs. - 5.4 kg	4.05
---------------	------------------------	-------	----	------------------	------

Jumbo Bowl Setting Wax Rings fit 3" (7.62 cm) and 4" (10.16 cm) drains. 40% more wax than regular ring. Saves labor time on installations and makes for a more positive seal.



**FLEX-O-SEAL REGULAR WAX RINGS WITH BRASS BOLT KIT**

<b>FOS1RB</b>	Regular with 1/4" x 2-1/4" Bolt Kit	Boxed	48	26 lbs. - 11.8 kg	5.37
<b>FOS1RB-D*</b>	Regular with 1/4" x 2-1/4" Bolt Kit (Double Nut / Double Washer)	Boxed	48	29 lbs. - 13.2 kg	5.68

FOS1RB contains: 1 each S1WR with 1 each FB101 (Poly Bagged 2 each 1/4" x 2-1/4" Solid Brass Flange Bolts, Brass Plated Open End Acorn Hex Nuts and Plated Steel Round Washers). FOS1RB-D contains: 1 each S1WR with 1 each FB101-D (Poly Bagged 2 each 1/4" x 2-1/4" Solid Brass Flange Bolts, 4 each Brass Plated Open End Acorn Hex Nuts and 4 each Plated Steel Round Washers).



**FLEX-O-SEAL FLANGED WAX RINGS WITH BRASS BOLT KIT**

<b>FOS1SB</b>	Flanged with 1/4" x 2-1/4" Bolt Kit	Boxed	24	18 lbs. - 8.2 kg	6.38
<b>FOS1SB-D*</b>	Flanged with 1/4" x 2-1/4" Bolt Kit (Double Nut / Double Washer)	Boxed	24	20 lbs. - 9.1 kg	6.64

FOS1SB contains: 1 each S1WS with 1 each FB101 (Poly Bagged 2 each 1/4" x 2-1/4" Solid Brass Flange Bolts, Brass Plated Open End Acorn Hex Nuts and Plated Steel Round Washers). FOS1SB-D contains: 1 each S1WS with 1 each FB101-D (Poly Bagged 2 each 1/4" x 2-1/4" Solid Brass Flange Bolts, 4 each Brass Plated Open End Acorn Hex Nuts and 4 each Plated Steel Round Washers).



**FLEX-O-SEAL FLANGED JUMBO WAX RINGS WITH BRASS BOLT KIT**

<b>FOS1SJB-D*</b>	Jumbo Flanged with 1/4" x 3-1/2" Bolt Kit (Double Nut / Double Washer)	Boxed	24	20 lbs. - 9.1 kg	7.13
-------------------	--	-------	----	------------------	------

FOS1SJB-D contains: 1 each FOS1SJ with 1 each contains: 1 each FB103-D (Poly Bagged 2 each 1/4" x 3-1/2" Solid Brass Flange Bolts, 4 each Brass Plated Open End Acorn Hex Nuts and 4 each Plated Steel Round Washers).



**FLEX-O-SEAL REGULAR WAX RINGS WITH BRASS PLATED DOUBLE NUT/DOUBLE WASHER BOLT KIT** Economical prepackaged kits with extra nuts/washers.

<b>FOS1RP-D*</b>	Regular with 1/4" x 2-1/4" Bolt Kit (Double Nut / Double Washer)	Boxed	48	31 lbs. - 14.1 kg	4.76
------------------	--	-------	----	-------------------	------

FOS1RP-D contains: 1 each S1WR with 1 each contains: 1 each FB300-D (Poly Bagged 2 Each Brass Plated Steel Flange Bolts, 4 Each Plated Steel Open End Acorn Hex Nuts and 4 Each Plated Steel Round Washers).



Pallet Quantities for Wax Rings: S1WR = 84 Cases, S1WS = 84 Cases.

\*WITH DOUBLE NUT AND DOUBLE WASHER. ALSO AVAILABLE WITH 2 ROUND PLASTIC RETAINER WASHERS IN PLACE OF DOUBLE NUT AND DOUBLE WASHER, AT NO ADDITIONAL COST. REPLACE "D" WITH "R" WHEN ORDERING SETS WITH RETAINER WASHERS.

**WAX RINGS, TANK BOLTS & GASKETS**



**FLEX-O-SEAL FLANGED WAX RINGS WITH BRASS PLATED DOUBLE NUT/DOUBLE WASHER BOLT KIT**  
Economical prepackaged kits with extra nuts/washers.

STOCK CODE	SIZE	CONTAINER	ITEMS/CASE	CASE WEIGHT	LIST PRICE EACH
FOS1SP-D*	Flanged with 1/4" x 2-1/4" Bolt Kit (Double Nut / Double Washer)	Boxed	24	18 lbs. - 8.2 kg	5.37

FOS1SP-D contains: 1 each S1WS with 1 each contains: 1 each FB300-D (Poly Bagged 2 Each Brass Plated Steel Flange Bolts, 4 Each Plated Steel Open End Acorn Hex Nuts and 4 Each Plated Steel Round Washers).



**FLEX-O-SEAL REGULAR WAX RING WITH URETHANE** Full size wax ring.

FOS1RU	Regular Wax Ring	Boxed	48	29 lbs. - 13.2 kg	4.55
--------	------------------	-------	----	-------------------	------

This is a urethane gasket made of tough, flexible urethane foam, which is completely impregnated with wax.



**FLEX-O-SEAL FLANGED WAX RING WITH URETHANE** Extra long flange is excellent for built-up floors.

FOS1SU	Flanged Wax Ring with Urethane	Boxed	24	16 lbs. - 7.3 kg	5.11
--------	--------------------------------	-------	----	------------------	------

This is a urethane gasket made of tough, flexible urethane foam, which is completely impregnated with wax. Combined with the plastic flange, it produces the strongest leakproof gasket on the market.



**FLEX-O-SEAL URINAL GASKET REINFORCED WITH URETHANE** Fits 2" outlet. Guaranteed for 10 years.

FOS2U	Urinal Gasket with Urethane	Boxed	12	5 lbs. - 2.3 kg	4.71
-------	-----------------------------	-------	----	-----------------	------



**SPONGE RUBBER BOWL GASKET AND BOLT KIT (POLY BAGGED)** Each Bag Contains 1 Sponge Rubber Gasket, 2 Each Solid Brass Tank Bolts, 4 Rubber Washers, 4 Brass Round Washers. Tank to Bowl Gasket Fits Most Close-Coupled Toilets. TBG10 comes with 2 Brass Hex Nuts and 2 Wing Nuts, TBG20 Comes with 4 Brass Hex Nuts.

TBG10	5/16" x 3" - .8 cm x 7.6 cm	Boxed	25	8 lbs. - 3.6 kg	9.82
TBG20	5/16" x 3" - .8 cm x 7.6 cm	Boxed	25	9 lbs. - 4.1 kg	9.82

**TBG10**  
2 Brass Hex Nuts  
and 2 Wing Nuts



**TBG20**  
4 Brass Hex Nuts

**WAX RING INSTALLATION INSTRUCTIONS**



1. Set the toilet bowl upside down on a smooth and soft surface. Remove the plastic tray from the wax ring and place it around the discharge opening with the flange pointing away from the bowl. Press the wax ring softly onto the toilet to install.



2. Turn the toilet and place it over the floor ensuring that its discharge opening is perfectly aligned with the drain hole in the floor. Twist it gently to ensure seal.

3. Set screws to secure the toilet on the floor.

\*WITH DOUBLE NUT AND DOUBLE WASHER. ALSO AVAILABLE WITH 2 ROUND PLASTIC RETAINER WASHERS IN PLACE OF DOUBLE NUT AND DOUBLE WASHER, AT NO ADDITIONAL COST. REPLACE "D" WITH "R" WHEN ORDERING SETS WITH RETAINER WASHERS.

**ANTI-FREEZE**

**FREEZE-FIGHTER ANTI-FREEZE CONCENTRATE** Nontoxic, **Aqua Blue Color** Anti-Freeze for Protecting Heating, Cooling, Pool and Potable Water Systems. Burst Protection to -100°F (-73°C). Freeze Protection to -60°F (-51°C). **MADE IN THE U.S.A.**



STOCK CODE	SIZE	CONTAINER	ITEMS/CASE	CASE WEIGHT	LIST PRICE EACH
FF1	Gallon - 3.785 L	Plastic Jug w/Spout	6	57 lbs. - 25.9 kg	58.38
FF5	5 Gallon - 18.9 L	Pail w/Handle	1	44 lbs. - 20.0 kg	273.58
FF55	55 Gallon - 208 L	55 Gallon Drum	1	515 lbs. - 233.6 kg	2879.09
FF275	275 Gallon - 1041 L	275 Gallon Tote	1	2575 lbs. - 1168 kg	CALL FOR PRICE

**FREEZE-POINT -100 ANTI-FREEZE SOLUTION** Nontoxic, **Blue Color** Anti-Freeze for Protecting Heating, Cooling, Pool and Potable Water Systems. Burst Protection to -100°F (-73°C). Freeze Protection to -50°F (-46°C). **MADE IN THE U.S.A.**



FP1	Gallon - 3.785 L	Plastic Jug w/Spout	6	58 lbs. - 26.3 kg	45.91
FP5	5 Gallon - 18.9 L	Pail w/Handle	1	45 lbs. - 20.4 kg	202.10
FP55	55 Gallon - 208 L	55 Gallon Drum	1	515 lbs. - 233.6 kg	2073.28
FP275	275 Gallon - 1041 L	275 Gallon Tote	1	2575 lbs. - 1168 kg	CALL FOR PRICE

**FREEZE-FIGHTER ANTI-FREEZE SOLUTION** Nontoxic, **Pink Color** Anti-Freeze for Protecting Heating, Cooling, Pool and Potable Water Systems. Burst Protection to -50°F (-46°C). Freeze Protection to -15°F (-26°C). **MADE IN THE U.S.A.**



AF1	Gallon - 3.785 L	Plastic Jug w/Spout	6	57 lbs. - 25.9 kg	33.61
AF5	5 Gallon - 18.9 L	Pail w/Handle	1	44 lbs. - 20.0 kg	159.53
AF55	55 Gallon - 208 L	55 Gallon Drum	1	500 lbs. - 226.8 kg	1650.40
AF275	275 Gallon - 1041 L	275 Gallon Tote	1	2500 lbs. - 1134 kg	CALL FOR PRICE

**SOLAR HI-TEMP HEAT TRANSFER FLUID AND ANTI-FREEZE SOLUTION** Nontoxic, **Blue Color** Glycerin Based, Heat Transfer Fluid and Anti-Freeze Solution with special anti-corrosion inhibitors and color indicators, that provides heat transfer up to 356°F (180°C). Burst protection to -50°F (-46°C). Freeze protection to -15°F (-26°C). Recommended for vacuum tube solar collectors. **MADE IN THE U.S.A.**



SH5	5 Gallon - 18.9 L	Pail w/Handle	1	51 lbs. - 23.1 kg	294.80
SH55	55 Gallon - 208 L	55 Gallon Drum	1	580 lbs. - 263.1 kg	3104.64
SH275	275 Gallon - 1041 L	275 Gallon Tote	1	2900 lbs. - 1315 kg	CALL FOR PRICE

**FROST-PROOF PG38 ANTI-FREEZE** Nontoxic, **Red Color** propylene glycol based Anti-Freeze for all types of wet fire sprinkler systems, excluding CPVC, that provides burst protection to -50°F (-46°C). **FROST-PROOF PG38** is a 38% pre-blend that conforms to NFPA standards to allow for direct replacement of Anti-Freeze in the system. No dilution is required. **MADE IN THE U.S.A.**



FPPG5	5 Gallon - 18.9 L	Pail w/Handle	1	44 lbs. - 20.0 kg	159.53
FPPG55	55 Gallon - 208 L	55 Gallon Drum	1	500 lbs. - 226.8 kg	1649.91
FPPG275	275 Gallon - 1041 L	275 Gallon Tote	1	2500 lbs. - 1134 kg	CALL FOR PRICE

**FROST-PROOF GL48 ANTI-FREEZE** Nontoxic, **Orange Color** glycerine based Anti-Freeze for all types of wet fire sprinkler systems, including CPVC, that provides burst protection to -50°F (-46°C). **FROST-PROOF GL48** is a 48% pre-blend that conforms to NFPA standards to allow for direct replacement of Anti-Freeze in the system. No dilution is required. Formulated and approved for Wet BlazeMaster® and FlameGuard® CPVC Systems. **MADE IN THE U.S.A.**



FPGL5	5 Gallon - 18.9 L	Pail w/Handle	1	44 lbs. - 20.0 kg	228.95
FPGL55	55 Gallon - 208 L	55 Gallon Drum	1	500 lbs. - 226.8 kg	2411.79
FPGL275	275 Gallon - 1041 L	275 Gallon Tote	1	2500 lbs. - 1134 kg	CALL FOR PRICE



Pallet Quantities for Anti-Freeze: 1 Gallon = 27 Cases, 5 Gallon = 32 Pails  
 Contact J.C. Whitlam Manufacturing for custom blends and private label opportunities.  
 BlazeMaster® is a licensed trademark of The Lubrizol Corporation.  
 FlameGuard® is a registered trademark of Spears Manufacturing Company.



**LEAK DETECTORS, CEMENTS, SEALERS & CLEANERS**



**BIG BUBBLE GAS LEAK DETECTOR** Noncorrosive, Nonfreezing, Nontoxic **Fluorescent Yellow** Leak Detector for Natural Gas, Refrigeration, Nitrogen, Air, Carbon Dioxide and other Pressurized Gases. Meets ASTM G188-05. **MADE IN THE U.S.A. Not recommended for oxygen systems.**

STOCK CODE	SIZE	CONTAINER	ITEMS/CASE	CASE WEIGHT	LIST PRICE EACH
LD1OZ	1 oz. - 29.6 ml	Yorker Bottle	36	4 lbs. - 1.8 kg	3.23
LD8	1/2 Pint - 237 ml	Dauber Top Container	24	16 lbs. - 7.3 kg	8.99
LD1	Gallon - 3.785 L	Plastic Jug w/Spout	6	55 lbs. - 24.9 kg	41.53
LD5	5 Gallon - 18.9 L	Pail w/Handle	1	42 lbs. - 19.1 kg	190.95
LD55	55 Gallon - 208 L	55 Gallon Drum	1	502 lbs. - 227.7 kg	1880.55



**BIG BUBBLE GAS LEAK DETECTOR / SPECIAL SPRAY FORMULA** Noncorrosive, Nonfreezing, Nontoxic **Iridescent Blue** Leak Detector for Natural Gas, Refrigeration, Nitrogen, Air, Carbon Dioxide and other Pressurized Gases. Temperature Range: -10°F (-23°C) to 180°F (82°C). Meets ASTM G188-05. **MADE IN THE U.S.A. Not recommended for oxygen systems. SEE PAGE 34 FOR SPRAYERS.**

LDS	Pint - 473 ml	Container w/Sprayer	12	16 lbs. - 7.3 kg	16.90
LDS16	Pint - 473 ml	Plastic Container	12	15 lbs. - 6.8 kg	10.74
LDS32	Quart - .95 L	Container w/Sprayer	12	31 lbs. - 14.1 kg	20.55
LDS1	Gallon - 3.785 L	Plastic Jug w/Spout	6	55 lbs. - 24.9 kg	41.53
LDS5	5 Gallon - 18.9 L	Pail w/Handle	1	42 lbs. - 19.1 kg	190.95
LDS55	55 Gallon - 208 L	55 Gallon Drum	1	502 lbs. - 227.7 kg	1880.55



**HEAT-TYTE FURNACE CEMENT** Asbestos Free, Gray, High Heat Refractory and Retort Furnace Cement. Temperature Rating 0°F to 3000°F (-18°C to 1649°C). **MADE IN THE U.S.A.**

HT64	1/2 Gallon - 1.89 L	Plastic Pail w/Handle	6	44 lbs. - 20.0 kg	27.35
HT1	Gallon - 3.785 L	Plastic Pail w/Handle	4	60 lbs. - 27.2 kg	45.51



**SEAL-TYTE BOILER SEALER** Liquid Boiler Sealer for all Steam Systems. Fills and Seals Holes and Cracks in Steam Boilers. **MADE IN THE U.S.A. Not for use in boilers containing Anti-Freeze.**

STS32	Quart - .95 L	Plastic Jug w/Spout	12	40 lbs. - 18.1 kg	22.62
STS1	Gallon - 3.785 L	Plastic Jug w/Spout	6	57 lbs. - 25.9 kg	68.48



**BOILER-AIDE 2-N-1** All Purpose Boiler Cleaner and Treatment. Cleans all Dirty Boilers and Controls Sludge, Corrosion, Scale and Foaming. **MADE IN THE U.S.A.**

BT32	Quart - .95 L	Plastic Jug w/Spout	12	32 lbs. - 14.5 kg	19.93
BT1	Gallon - 3.785 L	Plastic Jug w/Spout	6	57 lbs. - 25.9 kg	62.15
BT5	5 Gallon - 18.9 L	Pail w/ Handle	1	44 lbs. - 20.0 kg	248.56
BT55	55 Gallon - 208.2 L	55 Gallon Drum	1	500 lbs. - 226.8 kg	2734.03



**SLUDGE • B • GONE\*\*** Liquid Fuel Oil Additive. Dissolves Sludge and Water in All Fuel Oils. **MADE IN THE U.S.A.**

SBG32	Quart - .95 L	Plastic Jug w/Spout	12	26 lbs. - 11.8 kg	17.68
SBG1	Gallon - 3.785 L	Metal Can w/Handle	4	52 lbs. - 23.6 kg	62.08

\*\*D.O.T. Classified Shipping Items. See Page 39.



**LEAK LOCK** A resin based soft setting brushable paste pipe joint compound resistant to all refrigerants, oils, water and most chemicals, liquids and gases. **MADE IN THE U.S.A.**

STOCK CODE	SIZE	CONTAINER	ITEMS/CASE	CASE WEIGHT	LIST PRICE EACH
HS10001	1-1/3 oz. - 39 ml	Plastic Tube	12	2 lbs. - .9 kg	9.02
HS10004	4 oz. - 118 ml	Plastic Bottle w/Brush Top	12	6 lbs. - 2.7 kg	24.66
HS10016	16 oz. - 473 ml	Plastic Jar w/Brush Top	12	19 lbs. - 8.6 kg	65.70
HS10128	Gallon - 3.785 L	Can	1	12 lbs. - 5.4 kg	552.80



**LEAK LOCK GOLD with Teflon®** A resin based soft setting brushable paste pipe joint compound with Teflon® resistant to all refrigerants, oils, water and most chemicals, liquids and gases. **MADE IN THE U.S.A.**

HS11001	1-1/3 oz. - 39 ml	Plastic Tube	12	2 lbs. - .9 kg	9.81
HS11004	4 oz. - 118 ml	Plastic Bottle w/Brush Top	12	5 lbs. - 2.3 kg	25.68
HS11016	16 oz. - 473 ml	Plastic Jar w/Brush Top	12	17 lbs. - 7.7 kg	64.99
HS11128	Gallon - 3.785 L	Can	1	12 lbs. - 5.4 kg	568.22



**HEAT SHIELD** All-Temperature Barrier Spray prevents heat damage to nearby components during soldering, brazing or welding. Its unique no-drip formula sprays on as a gel and evaporates within 24 to 48 hours without staining. For use on all surfaces including but not limited to: wood, insulation, valves, piping and drywall. **MADE IN THE U.S.A.**

HS31032	32 oz. - .95 L	Spray Bottle	12	30 lbs. - 13.6 kg	25.21
---------	----------------	--------------	----	-------------------	-------



**SUPER FLUSH** Biodegradable internal coil cleaner and system flush. Removes gum, soot, moisture, sludge, grease, tar, particles, debris, organic acids, mineral acids, and carbon deposits. **MADE IN THE U.S.A.**

HS55032	32 oz. - .95 L	Plastic Bottle	12	26 lbs. - 11.8 kg	35.77
HS55128	Gallon - 3.785 L	Plastic Jug	6	53 lbs. - 24.0 kg	120.62



**EV COIL MAX** Powerful coil cleaner in powder form. Contains high performance corrosion inhibitors to help prevent future corrosion of the metals on both evaporator and condenser coils. **MADE IN THE U.S.A.**

HS56008	11.25 oz. - 333 ml	Plastic Jar	12	14 lbs. - 6.4 kg	20.17
---------	--------------------	-------------	----	------------------	-------



**HL COIL BRITE** High performance coil cleaner in a powder form. Acid based coil cleaner formulated to thoroughly clean the toughest coils using a controlled foaming action. **MADE IN THE U.S.A.**

HS57014	14 oz. - 414 ml	Plastic Jar	12	12 lbs. - 5.4 kg	23.79
---------	-----------------	-------------	----	------------------	-------



**HD JET FOAMER** Heavy duty alkaline based foaming aerosol coil cleaner. **MADE IN THE U.S.A.**

HS59520	20 oz. - 591 ml	Aerosol Can	12	19 lbs. - 8.6 kg	19.86
---------	-----------------	-------------	----	------------------	-------



**FILTER FAN & VENT CLEANER** Heavy duty cleaner specifically formulated for the heating, ventilation, air-conditioning and refrigeration industry. **MADE IN THE U.S.A.**

HS52032	32 oz. - .95 L	Plastic Spray Bottle	12	31 lbs. - 14.1 kg	32.26
HS52128	Gallon - 3.785 L	Plastic Jug Refill	6	55 lbs. - 24.9 kg	107.13



**SCREWDRIVERS**

**"6 IN 1" SLOTTED/PHILLIPS™ SCREWDRIVER\*** All the drives of a "4 IN 1" plus: 1/4" (.64 cm) and 5/16" (.79 cm) nut drivers. Reversible Bits, Slotted 4-5 and Phillips™ #1 and Slotted 8-10 and Phillips™ #2. Stress relieved blast finished bits. Chrome / Nickel plated nut drivers and inner handle receptacle. **The Professional Choice.**



STOCK CODE	SIZE	CONTAINER	ITEMS/CASE	CASE WEIGHT	LIST PRICE EACH
#4	Slotted Bits 4-5 and 8-10 and Phillips™ #1 and #2	Display Box	12	5 lbs. - 2.3 kg	14.64
#4A	Slotted Bits 4-5 and 8-10 and Phillips™ #1 and #2	Display Box	12**	5 lbs. - 2.3 kg	14.64

\*\*Special order 72 or more "6 IN 1" screwdrivers of the #4A and have your company name imprinted on the handle (up to 30 characters). High visibility handle. Allow 3 weeks for delivery. Guaranteed sale on special imprinted screwdrivers does not apply.

**REPLACEMENT BITS FOR #4, #4A.** \* #41 - Reversible Bit, Slotted 4-5 and Phillips™ #1. #42 - Reversible Bit, Slotted 8-10 and Phillips™ #2.



#41	Slotted 4-5 and Phillips™ #1	Boxed	10	1 lb. - 0.5 kg	4.62
#42	Slotted 8-10 and Phillips™ #2	Boxed	10	1 lb. - 0.5 kg	4.62

**"6 IN 1" SLOTTED/PHILLIPS™ SCREWDRIVER\*** All the drives of a "4 IN 1" plus: 1/4" (.64 cm) and 5/16" (.79 cm) nut drivers. Reversible Bits, Slotted 4-5 and 8-10, and Phillips™ #1 and #2. Cushion Grip. Stress relieved blast finished bits. Chrome / Nickel plated nut drivers and inner handle receptacle. **The Professional Choice.**



#5	Slotted Bits 4-5 and 8-10 and Phillips™ #1 and #2	Display Box	12	6 lbs. - 2.7 kg	17.82
#5A	Slotted Bits 4-5 and 8-10 and Phillips™ #1 and #2	Display Box	12**	6 lbs. - 2.7 kg	17.82

\*\*Special order 72 or more "6 IN 1" Screwdrivers of the #5A and have your company name imprinted on the black grip (up to 15 characters). (High visibility handle with black grip). Allow 3 weeks for delivery. Guaranteed sale on special imprinted screwdrivers does not apply.

**REPLACEMENT BITS FOR #5, and #5A** \* #43 - Reversible Bit, Slotted 4-5 and 8-10. #44 - Reversible Bit, Phillips™ #1 and #2.



#43	Slotted 4-5 and 8-10	Boxed	10	1 lb. - 0.5 kg	4.62
#44	Phillips™ #1 and #2	Boxed	10	1 lb. - 0.5 kg	4.62

**Purchase 72 or More "6 IN 1" Screwdrivers and Have Your Company Name Imprinted on the Handle**



**STOCK CODE #4A**



**Your Choice of Color for the Handle With Up to 30 Characters.**  
RED, BLACK or NAVY BLUE Handles with White Imprint



Available Handle Colors

**STOCK CODE #5A**

White Imprint (up to 15 characters) (Available only in Yellow)

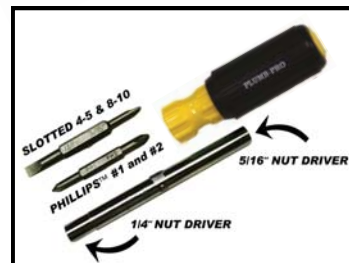

\*NOTE: Screwdriver Bits and Inspection Mirrors are considered expendable materials and therefore are not covered by the Warranty.





STRAPS

**BLACK RUBBER UTILITY STRAPS** Professional Quality EPDM Rubber Tie-down Utility Straps with exceptional strength. Squared head and tapered neck reduces strap stress. "S" Hooks are attached to straps. Made from UV resistant EPDM rubber. **MADE IN THE U.S.A.**

STOCK CODE	SIZE	CONTAINER	ITEMS/CASE	CASE WEIGHT	LIST PRICE EACH
#US9	9" - 23 cm	Boxed	50	10 lbs. - 4.5 kg	2.00
#US9A	9" - 23 cm	Boxed	12	3 lbs. - 1.4 kg	2.22
#US15	15" - 38 cm	Boxed	50	11 lbs. - 5.0 kg	2.38
#US15A	15" - 38 cm	Boxed	12	4 lbs. - 1.8 kg	2.62
#US20	20" - 51 cm	Boxed	50	12 lbs. - 5.4 kg	2.97
#US20A	20" - 51 cm	Boxed	12	4 lbs. - 1.8 kg	3.28
#US31	31" - 79 cm	Boxed	50	17 lbs. - 7.7 kg	3.44
#US31A	31" - 79 cm	Boxed	12	5 lbs. - 2.3 kg	3.75
#US41	41" - 104 cm	Boxed	50	20 lbs. - 9.1 kg	5.20
#US41A	41" - 104 cm	Boxed	12	5 lbs. - 2.3 kg	5.70

**NYLON WEB CAM BUCKLE UNIVERSAL TIE-DOWN STRAP** Nylon Webbing, Non-Slip Cam Buckle Strap Rated for up to 1200 lbs. (544 kg). Colors may vary. **MADE IN THE U.S.A.**

#WS10	1" x 10' 2.54 cm x 3.05 m	Boxed (Clamshell)	6	9 lbs. - 4.1 kg	30.12
-------	------------------------------	-------------------	---	-----------------	-------

**NYLON WEB RATCHET TYPE UNIVERSAL TIE-DOWN STRAP** Yellow Nylon Webbing, Non-Slip Ratchet Type Strap Rated for up to 3000 lbs. (1361 kg). Colors may vary. **MADE IN THE U.S.A.**

#WS16	1" x 16' 2.54 cm x 4.88 m	Boxed (Clamshell)	4	8 lbs. - 3.6 kg	66.40
-------	------------------------------	-------------------	---	-----------------	-------

**NYLON WEB RATCHET TYPE UNIVERSAL TIE-DOWN STRAP** Yellow 1-3/4" x 25' (4.45 cm x 7.62 m) Ratchet Type Strap Rated for up to 5500 lbs. (2495 kg). Excellent for large delivery trucks. Ratchet can be permanently attached to truck. End hook is standard size that fits most truck rails. Colors may vary. **MADE IN THE U.S.A.**

#WS25	1-3/4" x 25' 4.45 cm x 7.62 m	Boxed	1	6 lbs. - 2.7 kg	122.88
-------	----------------------------------	-------	---	-----------------	--------



PICK MATTOCK & SLEDGE HAMMERS

**SUPER PICK MATTOCK 36" (.91 m) FIBERGLASS HANDLE\*** Safety grip for easier handling with gloves, reduces fatigue. Forged heat treated and ground heads. 19-1/2" (49.5 cm) tip to tip. **MADE IN THE U.S.A.**

#279	19-1/2" Head, 36" Handle 49.5 cm Head, .91 m Handle	Bundled	1	9 lbs. - 4.1 kg	134.36
------	--	---------	---	-----------------	--------

**MINI SUPER FIBERGLASS HANDLE SLEDGE HAMMER** Ideal for delivering heavy blows where space to swing is limited. Compact, well balanced drop forged carbon steel head mounted to a solid fiberglass handle. Safety grip for additional control. Fiberglass handle also reduces fatigue. **MADE IN THE U.S.A.**

#58	2 lbs. - 0.9 kg 10" (25.4 cm) Handle	Boxed	1	3 lbs. - 1.4 kg	83.13
-----	---	-------	---	-----------------	-------

**SUPER FIBERGLASS HANDLE, FULL SIZE SLEDGE HAMMERS\*** The toughest, most durable sledge hammer available. Safety grip for easier handling with gloves. Fiberglass handle also reduces fatigue. **MADE IN THE U.S.A.**

#334	8 lbs. - 3.6 kg	Bundled	1	10 lbs. - 4.5 kg	134.55
#278	10 lbs. - 4.5 kg	Bundled	1	12 lbs. - 5.4 kg	166.66
#336	12 lbs. - 5.4 kg	Bundled	1	14 lbs. - 6.4 kg	178.24
#337	16 lbs. - 7.3 kg	Bundled	1	18 lbs. - 8.2 kg	202.15

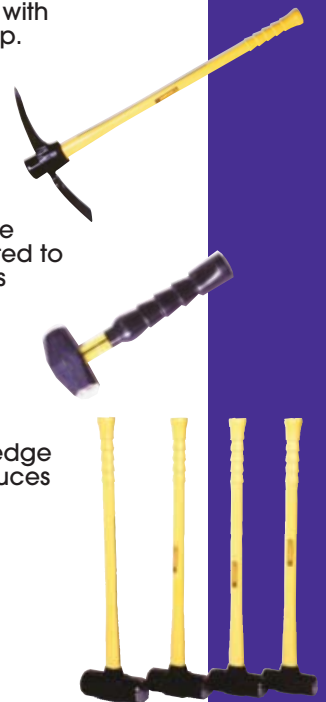

\*Replacement Handles are available for the Pick Mattocks and full size Sledge Hammers.

## SHOVELS & SPADES

**ROUND POINT SUPER SHOVEL 48" (1.2 m) FIBERGLASS HANDLE\*** #2 heavy gauge blade, forward turned step. Used for digging in hard and soft soil. **MADE IN THE U.S.A.**

STOCK CODE	SIZE	CONTAINER	ITEMS/CASE	CASE WEIGHT	LIST PRICE EACH
#283	8-3/4" x 12" Blade 48" Handle 22.22 cm x 30.48 cm Blade 1.2 m Handle	Bundled	3	17 lbs. - 7.7 kg	106.97

**SQUARE POINT SUPER SHOVEL 48" (1.2 m) FIBERGLASS HANDLE\*** #2 heavy gauge blade, forward turned step. Used for shoveling gravel, dirt and loose material. **MADE IN THE U.S.A.**

#284	9-1/2" x 12" Blade 48" Handle 24.13 cm x 30.48 cm Blade 1.2 m Handle	Bundled	3	15 lbs. - 6.8 kg	99.51
------	---	---------	---	------------------	-------

**TRENCH SUPER SHOVEL 48" (1.2 m) FIBERGLASS HANDLE\*** Cut down hollow back shovel blades simplify cleaning soil from machine dug trenches. The lift angle of the shovel blade is 32°. **MADE IN THE U.S.A.**

#318	4" x 12" Blade, 48" Handle 10.16 cm x 30.48 cm Blade 1.2 m Handle	Bundled	3	12 lbs. - 5.4 kg	96.69
#319	5" x 12" Blade, 48" Handle 12.7 cm x 30.48 cm Blade 1.2 m Handle	Bundled	3	13 lbs. - 5.9 kg	93.68

**DRAIN SPADE / SHARP SHOOTER SUPER SHOVEL WITH FIBERGLASS HANDLE\*** Hollow back blade, forward turned step. Used for trenching deep and narrow holes. **MADE IN THE U.S.A.**

#274	4-3/4" x 16" Blade, 48" Handle 12.1 cm x 40.64 cm Blade 1.2 m Handle	Bundled	3	14 lbs. - 6.4 kg	118.05
#275	4-3/4" x 16" Blade, 60" Handle 12.1 cm x 40.64 cm Blade 1.5 m Handle	Bundled	3	20 lbs. - 9.1 kg	141.60

**DRAIN SPADE / SHARP SHOOTER SUPER SHOVEL WITH FIBERGLASS "D" HANDLE\*** Hollow back blade, forward turned step. Used for cutting and trenching deep and narrow holes. **MADE IN THE U.S.A.**

#282	4-3/4" x 16" Blade, 27" Handle 12.1 cm x 40.64 cm Blade .69 m Handle	Bundled	2	9 lbs. - 4.1 kg	111.37
------	--	---------	---	-----------------	--------

**ROUND POINT SUPER SHOVEL 27" (.69 m) WITH FIBERGLASS "D" HANDLE\*** #2 heavy gauge blade, forward turned step. Used for digging in hard and soft soil. **MADE IN THE U.S.A.**

#326	8-3/4" x 12" Blade, 27" Handle 22.22 cm x 30.48 cm Blade .69 m Handle	Bundled	2	9 lbs. - 4.1 kg	110.15
------	---	---------	---	-----------------	--------

\*NOTE: Replacement Handles are available for Shovels and Spades. Call for pricing.

**Plumb-Pro Super Shovels are manufactured from the finest material available.**

- Comfortable ergonomically designed grip, made of long lasting vinyl.
- Fiberglass tubing consisting of millions of continuous parallel glass fibers in tension over a lightweight core.
- Solid fiberglass reinforcement at the critical stress point (patented).
- Adapter collar guarantees perfect stress bearing contact between handle and blade (patented).
- Super compression bar fills and reinforces the throat of hollow and closed back blades (patented).



**SOIL PROBES, METER KEYS & VALVE WRENCHES**

**FIBERGLASS SHAFT SOIL PROBES\*** With Fiberglass "T" handle. 1/2" (1.27 cm) diameter shaft has heavy duty zinc metal tip for durability and ease of extraction. Safe, nonconductive probe for locating irrigation, power and water lines. Probes are constructed of solid yellow fiberglass that will not weather, warp or splinter. **MADE IN THE U.S.A.**

STOCK CODE	SIZE	CONTAINER	ITEMS/CASE	CASE WEIGHT	LIST PRICE EACH
#280	48" Shaft - 1.2 m Shaft	Bundled	6	9 lbs. - 4.1 kg	57.28
#285	60" Shaft - 1.5 m Shaft	Bundled	6	10 lbs. - 4.5 kg	55.53

**REPLACEMENT ZINC PROBE TIP KIT\*** Contains Replacement Tip, Epoxy and Instructions. **MADE IN THE U.S.A.**

#395		Boxed	4	1 lb. - 0.5 kg	14.22
------	--	-------	---	----------------	-------

**20" (50.8 cm) MINI METER KEY** 8" (20.32 cm) handle, 20" (50.8 cm) length. Made from heavy 3/4" (1.91 cm) round bar stock. Stores compactly in tool box. High visibility yellow. Machined universal socket. **NOTE:** Fits old and new style meter valves. **MADE IN THE U.S.A.**

#64	20" Long, 8" Handle 50.8 cm Long 20.32 cm Handle	Bundled	1	4 lbs. - 1.8 kg	64.97
-----	--	---------	---	-----------------	-------

**42" (1.07 m) SUPER METER KEY** 24" (61 cm) handle, 42" (1.07 m) length. Made from heavy 1" (2.54 cm) square bar stock. High visibility yellow. Machined universal socket. **NOTE:** Fits old and new style meter valves. **MADE IN THE U.S.A.**

#156	42" Long, 24" Handle 1.07 m Long, 61 cm Handle	Bundled	1	8 lbs. - 3.6 kg	104.45
------	---	---------	---	-----------------	--------

**HEAVY METER KEYS** Curb Stop Key made from heavy 3/4" (1.91 cm) round bar stock. High visibility yellow. Machined universal socket. **NOTE:** Stepped Key fits old and new style meter valves. #403 Key is made to fit 1-1/2" openings. **MADE IN THE U.S.A.**

#65	42" Long, 18" Handle 1.07 m Long, 45.7 cm Handle	Bundled	1	8 lbs. - 3.6 kg	77.39
#397	6' Long, 24" Handle 1.83 m Long, 61 cm Handle	Bundled	1	13 lbs. - 5.9 kg	128.48
#400	7' Long, 24" Handle 2.13 m Long, 61 cm Handle	Bundled	1	14 lbs. - 6.4 kg	127.25
#403	7' Long, with 1-1/4" Wrench 2.13 m Long, with 3.18 cm Wrench	Bundled	1	15 lbs. - 6.8 kg	126.64
#401	8' Long, 24" Handle 2.43 m Long, 61 cm Handle	Bundled	1	16 lbs. - 7.3 kg	140.50

**TELESCOPIC VALVE WRENCHES** Adjustable length. Telescopic valve keys for 2-inch operating nuts makes transportation easier. Made of 1-1/2" square tube outside and 1-1/4" square tube inside. Has 24" handle, zinc plated "quick release" pin. High visibility yellow. 2" (5.08 cm) square socket. **MADE IN THE U.S.A.**

#399	3-1/2' - 6' Long, 24" Handle 1.07 m - 1.83 m Long 61 cm Handle	Bundled	1	13 lbs. - 5.9 kg	210.76
#402	4-1/2' - 8' Long, 24" Handle 1.40 m - 2.43 m Long 61 cm Handle	Bundled	1	15 lbs. - 6.8 kg	312.85

**3 IN 1 SERVICE KEY** Adjustable length. 2" (5.08 cm) Valve Wrench, Meter Key, and Handwheel attachment. Valve and Meter Key Attachments are Telescopic. Made of 1-1/2" square tube outside and 1-1/4" square tube inside. **MADE IN THE U.S.A.**

#404	46" - 80" Long, 24" Handle 1.17 m - 2.03 m Long 61 cm Handle	Bundled	1	13 lbs. - 5.9 kg	242.36
------	--	---------	---	------------------	--------



#404 collapses to 46" (1.17 m) Length x 4 1/2" (11.4 cm) Width for convenient storage



Handwheel attachment

\*NOTE: Probe Tips are considered expendable materials and therefore are not covered by the Warranty. We can make Meter Keys in any length. Call for pricing on lengths not shown above. We can also make Meter Keys that fit 1-1/4" pipe at no extra cost. Call for available sizes.





**TONGUE & GROOVE PLIERS/CHANNELLOCK BLUE®** grips. Right angled teeth that grip in all directions for maximum bite. Undercut tongue and groove won't slip.

**Permalock™** fastener eliminates nut and bolt failure. **MADE IN THE U.S.A.**



**#159 - CHANNELLOCK® #426**  
Length = 6-1/2" (16.51 cm)  
Adjustments = 5  
Capacity = 7/8" (22 mm)

**#162 - CHANNELLOCK® #430**  
Length = 10" (25.40 cm)  
Adjustments = 7  
Capacity = 2" (51 mm)

**#165 - CHANNELLOCK® #460**  
Length = 16" (40.64 cm)  
Adjustments = 8  
Capacity = 4-1/4" (108 mm)

**#161 - CHANNELLOCK® #420**  
Length = 9-1/2" (24.13 cm)  
Adjustments = 5  
Capacity = 1-1/2" (38 mm)

**#163 - CHANNELLOCK® #440**  
Length = 12" (30.48 cm)  
Adjustments = 7  
Capacity = 2-1/4" (57 mm)

**#196 - CHANNELLOCK® #480**  
Length = 20-1/4" (51.44 cm)  
Adjustments = 12  
Capacity = 5-1/2" (140 mm)

STOCK CODE	SIZE	CONTAINER	ITEMS/CASE	CASE WEIGHT	LIST PRICE EACH
#159	6-1/2" - 16.51 cm	Boxed (Clamshell)	5	5 lbs. - 2.3 kg	34.05
#161	9-1/2" - 24.13 cm	Boxed (Clamshell)	5	5 lbs. - 2.3 kg	42.08
#162	10" - 25.40 cm	Boxed (Clamshell)	5	6 lbs. - 2.7 kg	43.91
#163	12" - 30.48 cm	Boxed (Clamshell)	5	8 lbs. - 3.6 kg	47.51
#165	16" - 40.64 cm	Boxed (Clamshell)	2	6 lbs. - 2.7 kg	81.02
#196	20-1/4" - 51.44 cm	Boxed (Clamshell)	2	9 lbs. - 4.1 kg	136.00

**CURVED JAW TONGUE & GROOVE PLIERS/CHANNELLOCK BLUE®** grips. Right angled teeth that grip in all directions for maximum bite. Undercut tongue and groove won't slip.

**Permalock™** fastener eliminates nut and bolt failure. **MADE IN THE U.S.A.**



**#164 - CHANNELLOCK® #442**  
Length = 12" (30.48 cm)  
Adjustments = 7  
Capacity = 2-1/4" (57 mm)

#164	12" - 30.48 cm	Boxed (Clamshell)	5	8 lbs. - 3.6 kg	47.63
------	----------------	-------------------	---	-----------------	-------

**9-1/2" (24.13 cm) GRIPLOCK® UTILITY PLIERS/CHANNELLOCK BLUE®** grips. Ergonomically designed offset head for greater leverage. Special jaw design accommodates many shapes.

**Permalock™** fastener eliminates nut and bolt failure. **MADE IN THE U.S.A.**



**#168 - CHANNELLOCK® #G110**  
Length = 9-1/2" (24.13 cm)  
Adjustments = 5  
Capacity = 1-1/4" (32 mm)

#168	9-1/2" - 24.13 cm	Boxed (Clamshell)	5	6 lbs. - 2.7 kg	29.02
------	-------------------	-------------------	---	-----------------	-------

**CHANNELLOCK® LONG NOSE PLIERS WITH SIDE CUTTER/CHANNELLOCK BLUE®** grips. Cross hatching on jaws. Slender, perfectly mated jaws with no side wobble provide a firm grip on fine work in tight places. Sharp, hand honed side cutter is heat treated to hold its edge. High polished, carbon drop forged set.

**MADE IN THE U.S.A.**



**#175 - CHANNELLOCK® #326** Length = 6" (15.24 cm) with side cutter.  
**#178 - CHANNELLOCK® #317** Length = 7-1/2" (19.05 cm) with side cutter.

#175	6" - 15.24 cm	Boxed (Clamshell)	5	2 lbs. - 0.9 kg	55.53
#178	7-1/2" - 19.05 cm	Boxed (Clamshell)	5	3 lbs. - 1.4 kg	58.12



**PLIERS**

**SOFT TOUCH PLIERS\*** Protects decorative and bright plated plumbing fixtures. Soft jaws will not destroy plastic fittings. Maximum opening of 1-3/4" (4.45 cm) and a length of 10" (25.4 cm). Works great on shower arms. Automatically opens by the spring loaded mechanism. No need to open the handles by your fingers while in use. **The Professional Choice.**

STOCK CODE	SIZE	CONTAINER	ITEMS/CASE	CASE WEIGHT	LIST PRICE EACH
#393	10" - 25.4 cm	Bagged & Boxed	3	3 lbs. - 1.4 kg	62.19



**NYLON REPLACEMENT JAWS\*** For #393 Soft Touch Pliers.

#389	1-3/4" (4.45 cm)	Bagged & Boxed	3	1 lb. - 0.5 kg	10.78
------	------------------	----------------	---	----------------	-------

**SOFT JAW WONDER PLIERS\*** Wide jaw opening up to 2-3/4" (7 cm). Comes with round and square soft jaw inserts. Great for repair work on flush valves. Will not scratch plated finishes. Works on Delta® and other dome nuts. Will not crush threaded tail pieces. Automatically opens by the spring loaded mechanism. Opening range of 1" - 2-3/4" (2.5 cm - 7 cm) and a length of 10-1/2" (26.67 cm).

#394	10-1/2" - 26.67 cm	Bagged & Boxed	3	4 lbs. - 1.8 kg	67.11
------	--------------------	----------------	---	-----------------	-------

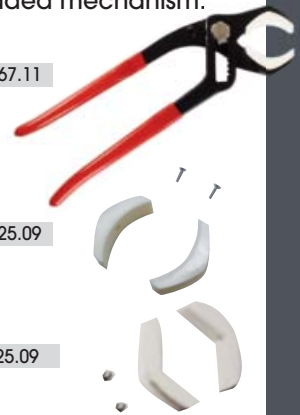

**ROUND REPLACEMENT JAWS\*** For #394 Soft Jaw Wonder Pliers.

#391	2-3/4" (7 cm)	Bagged & Boxed	3	1 lb. - 0.5 kg	25.09
------	---------------	----------------	---	----------------	-------

**SQUARE REPLACEMENT JAWS\*** For #394 Soft Jaw Wonder Pliers.

#392	2-3/4" (7 cm)	Bagged & Boxed	3	1 lb. - 0.5 kg	25.09
------	---------------	----------------	---	----------------	-------

**WRENCHES**

**TELESCOPIC BASIN WRENCH** Spring-loaded jaws of forged alloy steel provide fast, one-hand ratcheting in tight quarters. Tension plug holds head in any position up to 90 degree angle. Chrome-plated handle and shank. Telescopic shanks quickly adjust to 10" - 17" (25.4 cm - 43.2 cm).

#160	10" - 17" 25.4 cm - 43.2 cm	Bagged & Boxed	5	8 lbs. - 3.6 kg	18.83
------	--------------------------------	----------------	---	-----------------	-------



**NO HUB TORQUE WRENCH** For tightening 5/16" coupling nuts to 60 in. lbs. Automatic release at pre-set 60 in. lbs. T-Handle ratchets one way. Built-in reversing bar.

#243	5/16" - 0.79 cm	Bagged & Boxed	5	5 lbs. - 2.3 kg	33.82
------	-----------------	----------------	---	-----------------	-------

**HEAVY DUTY WATER HEATER ELEMENT WRENCH** A professional grade tool that easily removes elements without damaging the unit. Sliding "T" type handle allows for even pressure on both ends. Removes the most stubborn elements. 12 point heavy duty chrome plated steel socket and 18" (45.7 cm) "T" handle.

#145	1-1/2" x 3/4" Socket 18" Handle	Boxed	1	4 lbs. - 1.8 kg	81.65
#324	38 mm x 19 mm Socket 45.7 cm Handle	Boxed	1	3 lbs. - 1.4 kg	59.30
#325	1-1/2" x 3/4" Socket 38 mm x 19 mm Socket	Boxed	1	1 lb. - 0.5 kg	28.50



\*NOTE: The Soft Jaws of #393/#389 and #394/#391/#392 are considered expendable materials and therefore are not covered by the Warranty.

**SAWS**

**"T-HANDLE" CABLE SAW\*** For cutting PVC Pipe. For tight spots offering little clearance. Fits easily into tool box or pocket. Faster and easier than hacksaws in close quarters. The easy to use "T-Handles" offer less stress on the hands than loop handles. **MADE IN THE U.S.A.**

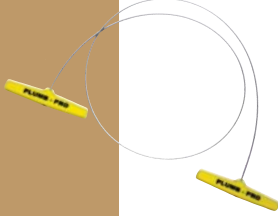

STOCK CODE	SIZE	CONTAINER	ITEMS/CASE	CASE WEIGHT	LIST PRICE EACH
#240	Approx. 36" Approx. 91.44 cm	Bagged & Boxed	12	1 lb. - 0.5 kg	12.05

**PROFESSIONAL HACKSAW 12" (30.48 cm) BLADE\*** Designed with the professional in mind. This saw features state of the art design. The blade can be set at two different angles, straight and 45 degree. Up to 10 blades can be stored in the top of the frame. Comes complete with a 12" (30.48 cm) Carbon Steel 18TPI Blade.



#67	12" Blade 18TPI 30.48 cm Blade 18TPI	Boxed	3	5 lbs. - 2.3 kg	34.26
-----	---	-------	---	-----------------	-------

**REPLACEMENT BLADES FOR #67 HACKSAW\***

#147 - Carbon steel blade. Low cost. Cuts wood, plastic and easy to machine metals such as conduit, aluminum, copper tubing, etc. Blade: 12" (30.48 cm) / 18TPI  
 #247 - Bi-Metal Construction. Tooth hardness RC 65-67. Cuts wood, plastic or any machinable metal, including conduit, stainless steel tubing, angle iron, copper tubing, structural materials, etc. Blade: 12" (30.48 cm) / 18TPI **MADE IN THE U.S.A.**



#147	12" Blade 18TPI 30.48 cm Blade 18TPI	Boxed	10	1 lb. - 0.5 kg	2.52
#247	12" Blade 18TPI 30.48 cm Blade 18TPI	Boxed	10	1 lb. - 0.5 kg	4.05

**PVC SAW - ALUMINUM HANDLE WITH 13" (33.02 cm) BLADE\*** Handsaw is designed for the plumber, electrician, and all professional general contractors. The unique design allows it to cut the following: fiberglass panels, PVC, ABS & CPVC plastic pipe, nail embedded wood, wallboard, brass and copper tubing, paneling and general purpose wood cutting.

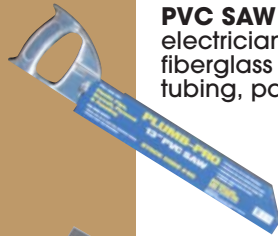

#182	19-1/2" - 49.53 cm Saw	Boxed	5	5 lbs. - 2.3 kg	26.59
------	------------------------	-------	---	-----------------	-------

**REPLACEMENT BLADES FOR #182 PVC SAW\***

#183	13" Blade 33.02 cm Blade	Boxed	5	3 lbs. - 1.4 kg	19.91
------	-----------------------------	-------	---	-----------------	-------

**PVC SAW - ALUMINUM HANDLE WITH 18" (45.72 cm) BLADE\*** Handsaw is designed for the plumber, electrician, and all professional general contractors. The unique design allows it to cut the following: Fiberglass panels, PVC, ABS & CPVC plastic pipe, nail embedded wood, wallboard, brass and copper tubing, paneling and general purpose wood cutting.



#180	23-1/2" - 59.69 cm Saw	Boxed	5	5 lbs. - 2.3 kg	28.24
------	------------------------	-------	---	-----------------	-------

**REPLACEMENT BLADES FOR #180 PVC SAW\***

#181	18" Blade 45.72 cm Blade	Boxed	5	3 lbs. - 1.4 kg	22.19
------	-----------------------------	-------	---	-----------------	-------

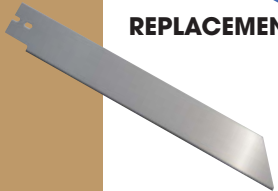

\*NOTE: Blades are considered expendable material and therefore are not covered by the Warranty.





PLASTIC PIPE CUTTERS



**"SNAPPER" TUBING CUTTER\*** High quality cutter for cutting plastic tubing, PVC, CPVC, polyethylene pipe and rubber hose through 1-1/4" (31.8 mm). Replaceable blade is made of stainless steel. Color: Yellow.



STOCK CODE	SIZE	CONTAINER	ITEMS/CASE	CASE WEIGHT	LIST PRICE EACH
#166	1" - 25.4 mm	Bagged & Boxed	10	5 lbs. - 2.3 kg	26.59

**REPLACEMENT BLADE WITH PIN FOR #166 "SNAPPER" TUBING CUTTER\***  
Made of stainless steel.

#167	1" - 25.4 mm	Bagged & Boxed	5	1 lb. - 0.5 kg	12.29
------	--------------	----------------	---	----------------	-------



**"MONGOOSE" 1" (25.4 mm) PLASTIC PIPE RATCHET CUTTER\*** Top quality professional ratchet cutter cuts PVC, CPVC, ABS, and other plastic pipe and tubing through 1" (25.4 mm). Heavy duty steel construction with replaceable stainless steel blade.



#15	1" - 25.4 mm	Bagged & Boxed	5	4 lbs. - 1.8 kg	56.59
-----	--------------	----------------	---	-----------------	-------

**REPLACEMENT BLADE FOR #15 "MONGOOSE"\*** Stainless steel blade with ratchet plate attached.

#16	1" - 25.4 mm	Bagged & Boxed	5	1 lb. - 0.5 kg	30.40
-----	--------------	----------------	---	----------------	-------

**REPLACEMENT SPRING SET FOR #15 "MONGOOSE"\***

#91	3 Springs per Bag 5 Bags per Case	Bagged & Boxed	5	1 lb. - 0.5 kg	7.11
-----	--------------------------------------	----------------	---	----------------	------

**COMPLETE REPAIR KIT - REPLACEMENT BLADE/SPRING SET FOR #15\* "MONGOOSE"**

#16-KIT	1 Each per Bag #16 Blade & #91 Springs	Bagged & Boxed	5	1 lb. - 0.5 kg	33.75
---------	---	----------------	---	----------------	-------



**"BADGER" 1-1/4" (31.8 mm) PLASTIC PIPE RATCHET CUTTER\*** Top quality professional ratchet cutter cuts PVC, CPVC, ABS and other plastic pipe and tubing through 1-1/4" (31.8 mm). Heavy duty steel construction with replaceable stainless steel blade.



#127	1-1/4" - 31.8 mm	Bagged & Boxed	3	3 lbs. - 1.4 kg	76.24
------	------------------	----------------	---	-----------------	-------

**REPLACEMENT BLADE FOR #127 "BADGER"\*** Stainless steel blade.

#128	1-1/4" - 31.8 mm	Bagged & Boxed	3	1 lb. - 0.5 kg	34.92
------	------------------	----------------	---	----------------	-------

**REPLACEMENT SPRING SET FOR #127 "BADGER"\***

#129	3 Springs per Bag 3 Bags per Case	Bagged & Boxed	3	1 lb. - 0.5 kg	9.77
------	--------------------------------------	----------------	---	----------------	------

**COMPLETE REPAIR KIT - REPLACEMENT BLADE/SPRING SET FOR #127 "BADGER"\***

#128-KIT	1 Each per Bag #128 Blade & #129 Springs	Bagged & Boxed	3	1 lb. - 0.5 kg	40.22
----------	---	----------------	---	----------------	-------



**"SABERTOOTH" 1-5/8" (42 mm) O.D. PLASTIC PIPE RATCHET CUTTER\*** Top quality professional ratchet cutter cuts PVC, CPVC, ABS and other plastic conduit and tubing through 1-5/8" (42 mm) O.D. V Blade is ideal for thin wall pipe. NO TOOLS REQUIRED TO CHANGE BLADE.



#38	1-5/8" - 42 mm	Bagged & Boxed	3	3 lbs. - 2.7 kg	76.24
-----	----------------	----------------	---	-----------------	-------

**REPLACEMENT BLADE FOR #38 "SABERTOOTH"\***

#39	1-5/8" - 42 mm	Bagged & Boxed	3	1 lb. - 0.5 kg	34.92
-----	----------------	----------------	---	----------------	-------

**REPLACEMENT SPRING SET FOR #38 "SABERTOOTH"\***

#40	3 Springs per Bag 2 Bags per Case	Bagged & Boxed	3	1 lb. - 0.5 kg	9.79
-----	--------------------------------------	----------------	---	----------------	------

**REPLACEMENT PIN FOR #38 "SABERTOOTH"\***

#37	Blade Pin	Bagged & Boxed	3	1 lb. - 0.5 kg	7.42
-----	-----------	----------------	---	----------------	------

**COMPLETE REPAIR KIT - REPLACEMENT BLADE/SPRING SET FOR #38 "SABERTOOTH"\***

#39-KIT	1 Each per Bag #39 Blade, #40 Springs & #37 Pin	Bagged & Boxed	3	1 lb. - 0.5 kg	40.26
---------	--	----------------	---	----------------	-------

PLASTIC PIPE CUTTERS

**BARRACUDA**  
PLASTIC PIPE CUTTER



**"BARRACUDA" 1-1/2" (38.1 mm) PLASTIC PIPE RATCHET CUTTER\*** Top quality professional ratchet cutter cuts PVC, CPVC, ABS and other plastic conduit and tubing through 1-1/2" (38.1 mm). Heavy duty steel construction with replaceable stainless steel blade.

STOCK CODE	SIZE	CONTAINER	ITEMS/CASE	CASE WEIGHT	LIST PRICE EACH
#130	1-1/2" - 38.1 mm	Bagged & Boxed	2	6 lbs. - 2.7 kg	115.42

**REPLACEMENT BLADE FOR #130 "BARRACUDA"\*** Stainless steel blade.

#131	1-1/2" - 38.1 mm	Bagged & Boxed	2	1 lb. - 0.5 kg	49.79
------	------------------	----------------	---	----------------	-------

**REPLACEMENT SPRING SET FOR #130 "BARRACUDA"\***

#132	3 Springs per Bag 2 Bags per Case	Bagged & Boxed	2	1 lb. - 0.5 kg	9.77
------	--------------------------------------	----------------	---	----------------	------

**COMPLETE REPAIR KIT - REPLACEMENT BLADE/SPRING SET FOR #130 "BARRACUDA"\***

#133-KIT	1 Each per Bag #131 Blade & #132 Springs	Bagged & Boxed	2	1 lb. - 0.5 kg	53.58
----------	---	----------------	---	----------------	-------



**PIRAÑA**  
PLASTIC PIPE CUTTER



**"PIRAÑA" ONE HANDED 2" (50.8 mm) PLASTIC PIPE RATCHET CUTTER\*** Top quality professional ratchet cutter cuts all types of plastic pipe and conduit through 2" (50.8 mm) in diameter. One handed operation and heavy duty steel construction.

#20	2" - 50.8 mm	Bagged & Boxed	2	4 lbs. - 1.8 kg	124.17
-----	--------------	----------------	---	-----------------	--------

**REPLACEMENT BLADE FOR #20 "PIRAÑA"\***

#21	2" - 50.8 mm	Bagged & Boxed	2	2 lbs. - 0.9 kg	68.33
-----	--------------	----------------	---	-----------------	-------

**REPLACEMENT SPRING SET FOR #20 "PIRAÑA"\***

#22	2 Springs per Bag 5 Bags per Case	Bagged & Boxed	5	1 lb. - 0.5 kg	9.77
-----	--------------------------------------	----------------	---	----------------	------

**COMPLETE REPAIR KIT - REPLACEMENT BLADE/SPRING SET FOR #20 "PIRAÑA"\***

#23-KIT	1 Each per Bag #21 Blade & #22 Springs	Bagged & Boxed	2	2 lb. - 0.9 kg	74.19
---------	---	----------------	---	----------------	-------



**VIPER**  
PLASTIC PIPE CUTTER



**"VIPER" 2" (50.8 mm) PLASTIC PIPE RATCHET CUTTER\*** Top quality professional ratchet cutter cuts PVC, CPVC, ABS and other plastic pipe and tubing through 2" (50.8 mm). Heavy duty steel construction with quality replaceable stainless steel blade.

#17	2" - 50.8 mm	Bagged & Boxed	1	3 lbs. - 1.4 kg	195.32
-----	--------------	----------------	---	-----------------	--------

**REPLACEMENT BLADE FOR #17 "VIPER"\*** Stainless steel blade.

#18	2" - 50.8 mm	Bagged & Boxed	1	1 lb. - 0.5 kg	99.04
-----	--------------	----------------	---	----------------	-------

**REPLACEMENT SPRING SET FOR #17 "VIPER"\***

#92	2 Springs per Bag 5 Bags per Case	Bagged & Boxed	5	1 lb. - 0.5 kg	7.11
-----	--------------------------------------	----------------	---	----------------	------

**COMPLETE REPAIR KIT - REPLACEMENT BLADE/SPRING SET FOR #17 "VIPER"\***

#19-KIT	1 Each per Bag #18 Blade & #92 Springs	Bagged & Boxed	1	1 lb. - 0.5 kg	100.83
---------	---	----------------	---	----------------	--------



**GATOR BITE**  
PLASTIC PIPE CUTTER



**"GATOR BITE" 2-1/2" (63.5 mm) PLASTIC PIPE RATCHET CUTTER\*** Top quality professional ratchet cutter cuts all types of plastic pipe and conduit through 2-1/2" (63.5 mm) in diameter. Heavy duty steel construction.

#205	2-1/2" - 63.5 mm	Boxed	1	4 lbs. - 1.8 kg	201.16
------	------------------	-------	---	-----------------	--------

**REPLACEMENT BLADE FOR #205 "GATOR BITE"\***

#206	2-1/2" - 63.5 mm	Bagged & Boxed	1	2 lbs. - 0.9 kg	101.98
------	------------------	----------------	---	-----------------	--------

**REPLACEMENT SPRING SET FOR #205 "GATOR BITE"\***

#207	2 Springs per Bag 5 Bags per Case	Bagged & Boxed	5	1 lb. - 0.5 kg	22.36
------	--------------------------------------	----------------	---	----------------	-------

**COMPLETE REPAIR KIT - REPLACEMENT BLADE/SPRING SET FOR #205 "GATOR BITE"\***

#208-KIT	1 Each per Bag #206 Blade & #207 Springs	Bagged & Boxed	1	2 lb. - 0.9 kg	124.36
----------	---	----------------	---	----------------	--------



Cutters are packaged in clear plastic point of purchase display pouches suitable for hanging on a display. (Excluding #205)

\*NOTE: Blades and Springs are considered expendable materials and therefore are not covered by the Warranty



INTERNAL PIPE CUTTERS

**"RIPPER" CARBIDE BLADE INTERNAL PLASTIC PIPE CUTTER\*** 2 each 1-1/2" (3.81 cm) diameter fiber carbide blades per bag with 3" (7.62 cm) long zinc plated shaft that fits 1/4" (.64 cm) or 3/8" (.95 cm) drills. For cutting 2" (5.08 cm) or larger PVC or ABS plastic pipe. **WARNING - Do not operate cutter in reverse.**

STOCK CODE	SIZE	CONTAINER	ITEMS/CASE	CASE WEIGHT	LIST PRICE EACH
#192	1-1/2" - 3.81 cm	Bagged & Boxed	10	1 lbs. - 0.5 kg	16.78

**REPLACEMENT BLADES FOR #192\*** Fiber carbide blades.

#154	1-1/2" diameter - 3.81 cm 3 Blades per Bag 10 Bags per Case	Bagged & Boxed	10	1 lb. - 0.5 kg	15.25
------	---	----------------	----	----------------	-------

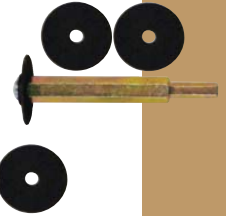

**"ZIPPY" METAL BLADE INTERNAL PLASTIC PIPE CUTTER\*** 1 each 1-1/2" (3.81 cm) diameter metal shear blade per bag with 4" (10.16 cm) long zinc plated shaft that fits 1/4" (.64 cm) or 3/8" (.95 cm) drills. For cutting 2" (5.08 cm) or larger PVC or ABS plastic pipe. **WARNING - Do not operate cutter in reverse.**

#150	1-1/2" diameter - 3.81 cm	Bagged & Boxed	10	1 lb. - 0.5 kg	32.19
------	---------------------------	----------------	----	----------------	-------

**"ZIPPY XL" LONG SHAFT METAL BLADE INTERNAL PLASTIC PIPE CUTTER\*** 1 each 1-1/2" (3.81 cm) diameter metal shear blade per bag with 7-1/2" (19.05 cm) long zinc plated shaft that fits 1/4" (.64 cm) or 3/8" (.95 cm) drills. For cutting 2" (5.08 cm) or larger PVC or ABS plastic pipe. **WARNING - Do not operate cutter in reverse.**

#152	1-1/2" diameter - 3.81 cm	Bagged & Boxed	5	1 lb. - 0.5 kg	35.51
------	---------------------------	----------------	---	----------------	-------

**REPLACEMENT BLADES FOR #150 and #152\*** Metal shear blades.

#151	1-1/2" diameter - 3.81 cm 2 Blades per Bag 10 Bags per Case	Bagged & Boxed	10	1 lb. - 0.5 kg	12.33
------	---	----------------	----	----------------	-------

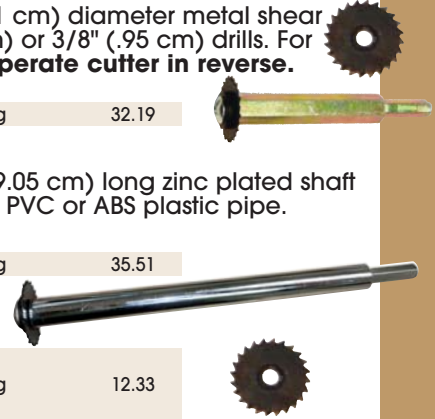

PIPE FITTING REAMERS

**"SOCKET RELIEVER" PIPE FITTING REAMERS** Removes Schedule 40 plastic pipe. Cuts ABS or PVC DWV pipe below slab. Fits 1/2" variable speed power drill.

#118	1/2" - 1.27 cm	Boxed	1	1 lb. - 0.5 kg	17.75
#119	3/4" - 1.91 cm	Boxed	1	1 lb. - 0.5 kg	17.75
#120	1" - 2.54 cm	Boxed	1	1 lb. - 0.5 kg	20.62
#123	1-1/2" - 3.81 cm	Boxed	1	1 lb. - 0.5 kg	22.66
#124	2" - 5.08 cm	Boxed	1	1 lb. - 0.5 kg	23.89
#125	3" - 7.62 cm	Boxed	1	1 lb. - 0.5 kg	38.88
#126	4" - 10.16 cm	Boxed	1	1 lb. - 0.5 kg	40.78

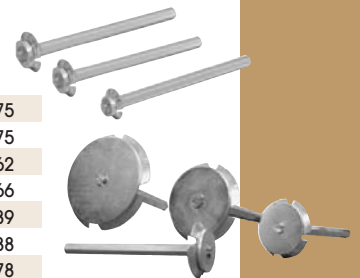

PIPE VENT SCREENS

**PIPE VENT SCREENS** Professionally made to prevent unwanted animals, leaves and debris from entering HVAC and plumbing vent pipe. Fabricated with Schedule 40 PVC and high quality Type 304 Stainless Steel Screen. No tools or glue are required for assembly. Simply press the vent screen into an existing fitting to seal out the pests and unwanted debris. The patented condensate channel allows for proper drainage that prevents a buildup of moisture and potential freezing of the screen.

#VS1	1" Pipe Vent Screen	Boxed	10	1 lb. - 0.5 kg	7.02
#VS15	1-1/2" Pipe Vent Screen**	Boxed	10	1 lb. - 0.5 kg	11.11
#VS2	2" Pipe Vent Screen**	Boxed	10	1 lb. - 0.5 kg	12.24
#VS3	3" Pipe Vent Screen**	Boxed	10	1 lb. - 0.5 kg	15.72
#VS4	4" Pipe Vent Screen**	Boxed	10	1 lb. - 0.5 kg	20.97
#VS6	6" Pipe Vent Screen**	Boxed	5	1 lb. - 0.5 kg	37.84

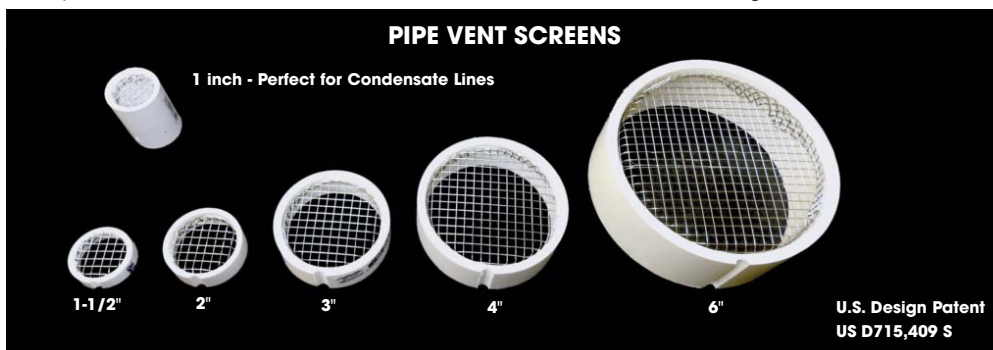

\*NOTE: Blades are considered expendable materials and therefore are not covered by the Warranty.

\*\*Fits inside of pipe fitting, fitting not included



## MARKING PAINT & MARKING GUNS

**PRO-STRIPE APWA INVERTED MARKING PAINT** A heavy duty, industrial paint with a water base formula that is fast drying, durable and non-clogging. Use in marking construction, excavation sites, underground utilities, landscaping, etc. Will not wash away or damage grass. Lead Free. **MADE IN THE U.S.A.**



STOCK CODE	SIZE	CONTAINER	ITEMS/CASE	CASE WEIGHT	LIST PRICE EACH
#MP-BLACK	17 oz. - 503 ml	Boxed	12	19 lbs. - 8.6 kg	10.78
#MP-BLUE	17 oz. - 503 ml	Boxed	12	19 lbs. - 8.6 kg	10.78
#MP-CLOUD WHITE	17 oz. - 503 ml	Boxed	12	19 lbs. - 8.6 kg	10.78
#MP-GREEN	17 oz. - 503 ml	Boxed	12	19 lbs. - 8.6 kg	10.78
#MP-HOT ORANGE	17 oz. - 503 ml	Boxed	12	19 lbs. - 8.6 kg	10.78
#MP-PINK	17 oz. - 503 ml	Boxed	12	19 lbs. - 8.6 kg	10.78
#MP-RED	17 oz. - 503 ml	Boxed	12	19 lbs. - 8.6 kg	10.78
#MP-YELLOW	17 oz. - 503 ml	Boxed	12	19 lbs. - 8.6 kg	10.78

**PRO-STRIPE INVERTED MARKING PAINT** Stripe any athletic field in minutes! Formulated to last long, remain bright and not harm grass or any sports field covering. Get up to 1/2 mile of 3-inch wide stripe per case.

#PSA-WHITE	18 oz. - 532 ml	Boxed	12	19 lbs. - 8.6 kg	11.66
#PSA-HOT ORANGE	18 oz. - 532 ml	Boxed	12	19 lbs. - 8.6 kg	11.66
#PSA-YELLOW	18 oz. - 532 ml	Boxed	12	19 lbs. - 8.6 kg	11.66
#PSA-RED	18 oz. - 532 ml	Boxed	12	19 lbs. - 8.6 kg	11.66
#PSA-NAVY BLUE	18 oz. - 532 ml	Boxed	12	19 lbs. - 8.6 kg	11.66

**PRO-STRIPER INVERTED AEROSOL MARKING MACHINE** Solid steel frame with fold-down handle. 10" wheels make it easy to maneuver. **For use with Pro-Stripe Traffic Inverted Marking Paint**

PRO-STRIPER	Universal	Boxed	1	22 lbs. - 10.0 kg	321.37
-------------	-----------	-------	---	-------------------	--------

**PRO-STRIPER MARKING GUN** A compact and lightweight tool used to apply marking paint in a wide range of marking applications.

#704	Universal	Boxed	1	1 lb. - 0.5 kg	37.60
------	-----------	-------	---	----------------	-------

**PRO-STRIPER MARKING WAND** A lightweight tool used to apply marking paint in a wide range of marking applications. Approximately 3 feet in length to make application of paint easy.

#705	Universal	Boxed	1	3 lbs. - 1.4 kg	52.95
------	-----------	-------	---	-----------------	-------

## TURF COLORANT & LEAK TRACER DYES



**GREENS COAT TURF COLORANT** A super concentrated green pigment with Bright-Fast™ Technology which will not harm turf grass and can be applied at any time during the year.

GC32	Quart - .95 L	Flat Top Can	12	33 lbs. - 15.0 kg	57.39
GC1	Gallon - 3.785 L	Paint Can w/Handle	4	36 lbs. - 16.3 kg	197.02
GC5	5 Gallon - 18.9 L	Pail w/Handle	1	53 lbs. - 24.0 kg	944.76

**FAST-TRAC YELLOW/GREEN LEAK TRACER DYE** A highly concentrated leak inspection dye that dissolves rapidly in water and provides a vivid fluorescent yellow/green color detectable in murky water, sewage or effluent. **MADE IN THE U.S.A.**

LTDG16	16 oz. - 473 ml	Plastic Container	12	15 lbs. - 6.8 kg	29.60
LTDG1	Gallon - 3.785 L	Plastic Jug w/Spout	4	37 lbs. - 16.8 kg	222.15
LTDG5	5 Gallon - 18.9 L	Pail w/Handle	1	42 lbs. - 19.1 kg	1046.33

**FAST-TRAC RED LEAK TRACER DYE** A highly concentrated leak inspection dye that dissolves rapidly in water and provides a vivid fluorescent red color detectable in murky water, sewage or effluent. **MADE IN THE U.S.A.**

LTDG16	16 oz. - 473 ml	Plastic Container	12	15 lbs. - 6.8 kg	29.60
LTDG1	Gallon - 3.785 L	Plastic Jug w/Spout	4	37 lbs. - 16.8 kg	222.15
LTDG5	5 Gallon - 18.9 L	Pail w/Handle	1	42 lbs. - 19.1 kg	1046.33

**FAST-TRAC BLUE LEAK TRACER DYE** A highly concentrated leak inspection dye that dissolves rapidly in water and provides a vivid non-fluorescent blue color detectable in murky water, sewage or effluent. **MADE IN THE U.S.A.**

LTDB16	16 oz. - 473 ml	Plastic Container	12	15 lbs. - 6.8 kg	29.60
LTDB1	Gallon - 3.785 L	Plastic Jug w/Spout	4	37 lbs. - 16.8 kg	222.15
LTDB5	5 Gallon - 18.9 L	Pail w/Handle	1	42 lbs. - 19.1 kg	1046.33



**CANS, DAUBERS, APPLICATORS, SPRAYERS & BOTTLES**

**CANS** Empty Screw Top Cans without Caps. For caps, see below. **MADE IN THE U.S.A.**

STOCK CODE	SIZE	CONTAINER	ITEMS/CASE	CASE WEIGHT	LIST PRICE EACH
#CHP	1/2 Pint - 237 ml	Boxed	24	5 lbs. - 2.3 kg	1.68
#CPP	Pint - 473 ml	Boxed	12	5 lbs. - 2.3 kg	2.52
#CQ	Quart - .95 L	Boxed	12	5 lbs. - 2.3 kg	4.08
#CQ100	Quart - .95 L	Boxed	100	38 lbs. - 17.2 kg	3.39

**WIDE MOUTH GALLON CAN WITH SCREW TOP LID**  
Opening of can is 2-7/8" (7.32 cm). **MADE IN THE U.S.A.**

#CGW	Gallon - 3.785 L	Boxed	6	10 lbs. - 4.5 kg	19.75
------	------------------	-------	---	------------------	-------

**DAUBER SCREW CAPS** Standard Dauber and Cap. For use on empty screw top Cans listed above. **MADE IN THE U.S.A.**

#DP	Pint - 473 ml	Boxed	50	2 lbs. - 0.9 kg	1.53
#DPA	Pint - 473 ml	Boxed	12	1 lb. - 0.5 kg	1.65
#DQ	Quart - .95 L	Boxed	50	3 lbs. - 1.4 kg	1.65
#DQA	Quart - .95 L	Boxed	12	1 lb. - 0.5 kg	1.79

**DAUBER SCREW CAPS** 1/2" Dauber and Cap. For use with CPVC Yellow Medium Bodied Low VOC Cement and empty screw top cans listed above. **MADE IN THE U.S.A.**

#DHP	Half Pint - 237 ml	Boxed	12	1 lb. - 0.5 kg	1.60
#DPS	Pint - 473 ml	Boxed	12	1 lb. - 0.5 kg	1.65

**GALLON CAN ROLLER** Applicator with Cap - Fits wide and standard mouth size.

#CGWR	12" - 30 cm	Boxed	12	4 lbs. - 1.8 kg	25.20
-------	-------------	-------	----	-----------------	-------

**GALLON CAN SWAB** Applicator with Cap - Fits wide and standard mouth size.

#CGWS	12" - 30 cm	Boxed	12	2 lbs. - .91 kg	24.31
-------	-------------	-------	----	-----------------	-------

**ROUND COTTON SWAB APPLICATOR** Wire Handle Swab. Total length 11" (28 cm). For applying large quantities of gasket lubricant or PVC cements and cleaners to pipe and fittings.

#GLS	11" x 2" - 28 x 5 cm	Boxed	50	7 lbs. - 3.2 kg	5.56
#GLSA	11" x 2" - 28 x 5 cm	Boxed	12	2 lbs. - 0.9 kg	6.12

**ACID & FLUX BRUSH** Metal Handle.

#BR1	3/8" Wide x 6" Long .95 cm Wide x 15.24 cm Long	Boxed	144	3 lbs. - 1.4 kg	0.33
------	--	-------	-----	-----------------	------

**FLUX BRUSH** Pipe Joint Compound and Flux Brush. Wood Handle.

#BR7	3/4" Wide x 7" Long 1.91 cm Wide x 17.78 cm Long	Boxed	36	2 lbs. - 0.9 kg	1.79
------	---	-------	----	-----------------	------

**PURE BRISTLE BRUSHES** Paint Brush Style. Wood Handle.

#PB1	1" - 2.54 cm	Boxed	36	2 lbs. - 0.9 kg	1.86
#PB2	2" - 5.08 cm	Boxed	24	2 lbs. - 0.9 kg	2.45
#PB3	3" - 7.62 cm	Boxed	24	3 lbs. - 1.4 kg	3.44
#PB4	4" - 10.16 cm	Boxed	12	2 lbs. - 0.9 kg	4.97

**SPRAYERS** Trigger Pump Plastic Sprayer with adjustable spray nozzle for use with pint or quart Leak Detector bottles. **MADE IN THE U.S.A.**

#SPR	Trigger Pump Sprayer for Pint (473 ml) Bottles	Boxed	6	1 lb. - 0.5 kg	4.90
#SPRL	Trigger Pump Sprayer for Quart (.95 L) Bottles	Boxed	6	1 lb. - 0.5 kg	5.86

**PLASTIC BOTTLES WITH PLASTIC SCREW CAPS**  
**MADE IN THE U.S.A.**

#B16	Pint - 473 ml	Boxed	6	1 lb. - 0.5 kg	3.18
#B32	Quart - .95 L	Boxed	12	2 lb. - 1.0 kg	3.79



## TOOLS, TWINE & TAPES

**MAGNETIC TORPEDO LEVEL** 9" Black, high impact plastic frame. Magnetic edge frees hands. Vials read plumb, level, 1/4" per 1 foot plumbing code slope and 45° top read window. V-grooved working edge fits on pipe or conduit.



STOCK CODE	SIZE	CONTAINER	ITEMS/CASE	CASE WEIGHT	LIST PRICE EACH
#12	9" - 23 cm	Bagged & Boxed	5	2 lbs. - 0.9 kg	16.24

**METAL STUD INSULATORS** Protects copper and polybutylene pipe from sharp edges of metal studs. Snaps into a 1-11/32" (3.41 cm) hole punched by **#398 SUPER STUD PUNCH**. Fits all 1/2" (1.27 cm), 3/4" (1.91 cm) and 1" (2.54 cm) copper or polypipe tubing. For use on all metal studs 18 gauge or lighter. Patented offset hole makes for better pipe alignment. Sold in full case quantities only. **MADE IN THE U.S.A.**



#24	1/2" - 1.27 cm	Bagged & Boxed	100	1 lb. - 0.5 kg	0.59
#25	3/4" - 1.91 cm	Bagged & Boxed	100	1 lb. - 0.5 kg	0.59
#26	1" - 2.54 cm	Bagged & Boxed	100	1 lb. - 0.5 kg	0.59

**SUPER STUD PUNCH** Extended throat. Cuts 3-1/2" (8.89 cm) from edge. Cuts heavy 18 gauge steel. Lightweight high strength aluminum alloy. Hole size 1-11/32" (3.41 cm). Offset handle gets into tight places easier. Better leverage for easier punching. Non-slip rubber grips. **MADE IN THE U.S.A.**



#398	1-11/32" Hole Size 3.41 cm Hole Size	Boxed	1	7 lbs. - 3.2 kg	540.48
------	---	-------	---	-----------------	--------

**4 - WAY VALVE KEY** For stop cocks, sill cocks and valves when handles have been removed. Fits 1/4" (.64 cm), 9/32" (.71 cm), 5/16" (.79 cm), 11/32" (.86 cm). Polished chrome finish.



#33	Universal	Bagged & Boxed	5	3 lbs. - 1.4 kg	15.60
-----	-----------	----------------	---	-----------------	-------

**MEASURING TAPE** High Impact Yellow Case. Tough tip stainless steel blade protector with 3 rivets virtually eliminates tip breakage. Three color blade with bold, precise numbers for easier reading.



#301	1" x 25' - 2.54 cm x 7.62 m	Bagged & Boxed	6	6 lbs. - 2.7 kg	24.71
------	-----------------------------	----------------	---	-----------------	-------

**YELLOW MASON TWINE\*** No. 18 - 275 ft. (84 m). Unaffected by cement. Rot proof. High strength for use as chalk line, plumb line, lead line. Rolls individually wrapped in clear plastic.



#46	No. 18 - 275' (84 m) Long	Boxed	12	5 lbs. - 2.3 kg	7.70
-----	---------------------------	-------	----	-----------------	------

**WIRE PULLING TWINE\*** Polypropylene twisted film. 1-Ply x 6500'; average break strength 200 lbs. (90.7 kg). Plastic bucket dispenser, made from high strength plastic.



#49	1-Ply x 6500' (200 lbs.) 1-Ply x 1981 m (90.7 kg)	Pail w/Handle	1	12 lbs. - 5.4 kg	114.36
-----	--	---------------	---	------------------	--------

**PVC PIPE WRAP TAPE\*** High quality polyethylene pipe wrap tape. All weather, moisture proof black pipe wrap tape. UPC listed.

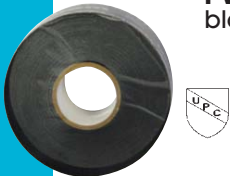

#143	10 mil x 2" x 100' 10 mil x 5.08 cm x 30.5 m	Boxed	36	40 lbs. - 18.1 kg	14.62
------	---	-------	----	-------------------	-------

**YELLOW WARNING BARRIER "CAUTION" TAPE\*** Durable 3 Mil thick PVC Plastic Tape, 3" (7.62 cm) wide. Bright yellow with **BOLD BLACK PRINT - "CAUTION CAUTION"**



#367	1000' long - 305 m long	Boxed	8	36 lbs. - 16.3 kg	33.82
#368	200' long - 61 m long	Boxed	10	9 lbs. - 4.1 kg	15.98

\*NOTE: Mason Twine, Wire Pulling Twine, Pipe Wrap Tape and Caution Tape are considered expendable materials and therefore are not covered by the Warranty.





**Stock Code**  
DISPLAY2

**Order \$1200.00 NET or more and receive a 2 Foot Point-of-Purchase Display Rack FREE!**

This light beige display rack contains three shelves and one base shelf for displaying **WHITLAM** products with an eye-catching two color sign. It is available full freight prepaid and allowed, when ordered with \$1200 NET billing value.

- Limit 1 free display rack per location.

**Display measures:**

24" (61 cm) long  
54" (137 cm) high  
18" (46 cm) deep  
Extra shelves: \$100.00 each  
Extra display: \$175.00 each

**Display ships with:**

10" adjustable shelves (2 each)  
12" adjustable shelf (1 each)  
12" base shelf (1 each)

**Receive a FREE Soil Probe Display Rack with orders of 24 or more Probes!**

This Point-of-Purchase Probe Display will display up to 24 - 48" (1.2 m) and/or 60" (1.5 m) Soil Probes. Display must be ordered on same order as the probes to qualify.

- Limit 1 display per wholesaler location.  
- Stock Code #272

**Order \$500.00 NET or more of: Shovels, Spades, Pick Mattock, and/or Sledge Hammers and receive one FREE Display Barrel!**



**Stock Code**  
BARREL



**Stock Code**  
#272

**Order \$1500.00 NET or more and receive a 4 Foot Gondola Display Rack FREE!**

This light beige display rack contains four shelves and one base shelf for displaying **WHITLAM** products with an eye-catching two color sign. It is available full freight prepaid and allowed, when ordered with \$1500 NET billing value.

- Limit 1 free display rack per location.

**FREE FLOW-AIDE Point-of-Purchase Display with Purchase of 6 ea. FLOW-KITS and 16 ea. FLOW32**

This free standing Point-of-Purchase display assists in promoting the FLOW-AIDE Descaler Kit and FLOW-AIDE Biodegradable Chemical Solution with its eye catching header and solid blue base. The self talking header highlights the multiple uses/advantages of this top quality chemical descaler.

**Display measures:**

28" (71 cm) long  
50" (127 cm) high  
14" (36 cm) deep

**Stock Code FLOW-DISPLAY**

Contains: 6 each **FLOW-KIT**  
16 each **FLOW32**

**Stock Code FLOW-DISPLAYC**

Contains: 6 each **FLOW-KITC\***  
16 each **FLOW32C\***



**Stock Code** DISPLAY4

**Display measures:**

48" (122 cm) long  
54" (137 cm) high  
18" (46 cm) deep  
Extra shelves: \$125.00 each  
Extra display: \$225.00 each

**Display ships with:**

10" adjustable shelves (3 each)  
12" adjustable shelf (1 each)  
12" base shelf (1 each)

**PLUMBING CENTER**

**Order the Following Products:**

- 1 case #393 - Soft Touch Pliers
- 1 case #394 - Soft Jaw Wonder Pliers
- 1 case CF5 - 1/2" Wire Handle Fitting Brush
- 1 case CF75 - 3/4" Wire Handle Fitting Brush
- 1 case TL1429 - "Talon" Professional High Density Gray PTFE Tape
- 1 case IG8 - 8 oz. "Blue Magic" Thread Compound
- 1 case IG16 - 16 oz. "Blue Magic" Thread Compound
- 1 case TAL8 - 8 oz. "Talon" PTFE Thread Compound
- 1 case TF8 - 8 oz. "Select-Unyte" PTFE Thread Compound
- 1 case TF16 - 16 oz. "Select-Unyte" PTFE Thread Compound
- 1 case MT1 - 14 oz. "Talon" Plumber's Putty
- 1 case MT5 - 5 lb. "Talon" Plumber's Putty
- 1 case PL8 - 8 oz. PVC Clear Medium Bodied Low VOC Cement
- 1 case PL16 - 16 oz. PVC Clear Medium Bodied Low VOC Cement
- 1 case PPL8 - 8 oz. Low VOC Purple Primer
- 1 case PPL16 - 16 oz. Low VOC Purple Primer
- 1 case TDC1 - 1 lb. "Talon" Drain Opener
- 1 case TFB80 - "Talon" Hand Cleaning Towels
- 1 case 18032 - 10.3 oz. DAP® White, Linen/Biscuit and/or Clear Caulk
- 1 case 08011 - 10.3 oz. DAP® Clear or White RTV Silicone Sealant
- 1 case S1WR - Regular Wax Ring
- 1 case S1WS - Flanged Wax Ring
- 1 case FOS1SJ - Jumbo Flanged Wax Ring
- 1 case TWF1 - 1 lb. "Talon" Water Soluble Paste Flux
- 1 case WP10 - 10 yd. Waterproof Blue Sand Cloth

**And Receive Prepaid Freight, 2% 60 Day Billing, Free 2 Foot Point-of-Purchase Display Rack & Free Case of 16 oz. "Talon" Citrus Lotion Hand Cleaner with Lanolin and Walnut Scrubbers (THC16).**



**IRRIGATION CENTER**

**Order the Following Products:**

- 25 case Mix of Solvent Weld Cements and Primers
- 1 case #166 - 1" "Snapper" Tubing Cutter
- 1 case #38 - 1-5/8" "Sabertooth" Plastic Pipe Ratchet Cutter
- 1 case #20 - 2" "Piraña" Plastic Pipe Ratchet Cutter
- 1 case #GLS - Cotton Swab Applicator
- 1 case GWP16 - 16 oz. "Glue-Wash" Pumice Hand Cleaner
- 1 case TAL8 - 8 oz. "Talon" PTFE Thread Compound

**And Receive Prepaid Freight, 2% 60 Day Billing, Free 2 Foot Point-of-Purchase Display Rack, Free Case of 4 oz. "Glue-Wash" (GWP4) Pumice Hand Cleaner.**



\*See terms of Guaranteed Sale and Return Policy on Page 39 of this price catalog.





**Order the Following Products:**

- 1 case #20 - 2" "Piraña" Plastic Pipe Ratchet Cutter
- 4 case Mix of "Pro-Stripe" Inverted Marking Paint
- 1 case #GLS - Gasket Lube Swabs
- 1 case CU16 - 1 lb. "TALON" Thread Compound
- 2 cases TL1429 - "Talon" Professional High Density Gray PTFE Tape
- 1 case LTDB16 - 16 oz. Fast-Trac Blue Leak Tracer Dye
- 1 case LTDG16 - 16 oz. Fast-Trac Yellow/Green Leak Tracer Dye
- 1 case LTDR16 - 16 oz. Fast-Trac Red Leak Tracer Dye
- 1 case TAL16 - 16 oz. "Talon" PTFE Thread Compound
- 1 case PPL16 - 16 oz. Low VOC Purple Primer
- 1 case WET16 - 16 oz. "Weatherproof" Clear Medium Bodied Wet/Dry Low VOC PVC Cement
- 1 case HDP16 - 16 oz. PVC Clear Heavy Duty Low VOC Cement
- 1 case GLP32 - 32 oz. "Blue Lube" Pipe Gasket Lubricant
- 1 case GWP16 - 16 oz. "Glue-Wash" Pumice Hand Cleaner
- 1 case PPL32 - 32 oz. Low VOC Purple Primer
- 1 case WET32 - 32 oz. "Weatherproof" Clear Medium Bodied Wet/Dry Low VOC PVC Cement
- 1 case HDP32 - 32 oz. PVC Clear Heavy Duty Low VOC Cement
- 1 case BD1 - 1 Gallon Black Dragon Gilsonite Asphalt Paint
- 3 case Mix of "Talon" Direct to Metal Paint

**And Receive Prepaid Freight, 2% 60 Day Billing, Free 2 Foot Point-of-Purchase Display Rack & Free Case of 16 oz. "Talon" Citrus Lotion Hand Cleaner with Lanolin and Walnut Scrubbers (THC16).**

**POOL/SPA CENTER**

**Order the Following Products:**

- 25 case Mix of Solvent Weld Cements and Primers
- 1 case #17 - 2" "Viper" Plastic Pipe Ratchet Cutter
- 1 case #20 - 2" "Piraña" Plastic Pipe Ratchet Cutter
- 1 case #166 - 1" "Snapper" Tubing Cutter
- 1 case #124 - 2" "Socket Reliever" Pipe Fitting Reamer
- 1 case IG2 - 2 oz. "Blue Magic" Industrial Grade Thread Sealant
- 1 case EPP4 - 4 oz. "Talon" Epoxy for Plastic
- 1 case TL1429 - "Talon" Professional High Density Gray PTFE Tape
- 1 case GWP16 - 16 oz. "Glue-Wash" Pumice Hand Cleaner
- 1 case TFB80 - "Talon" 9" x 12" Hand Cleaning Towels
- 1 case #MP-HOT ORANGE - 17 oz. "Pro-Stripe" Inverted Marking Paint

**And Receive Prepaid Freight, 2% 60 Day Billing, Free 2 Foot Point-of-Purchase Display Rack, Free Case of 4 oz. "Glue-Wash" (GWP4) Pumice Hand Cleaner.**



\*See terms of Guaranteed Sale and Return Policy on Page 39 of this price catalog.





**D.O.T. CLASSIFIED SHIPPING TERMS:** North American shipments containing Plastic Pipe Cements and Cleaners through quart size will be shipped Consumer Commodity ORM-D; gallon size requires the proper UN Number on Bills of Lading and a Flammable Red Label on all cartons. All cartons on shipments to overseas countries are required to have the proper UN Number on Bills of Lading and a Flammable Red Label on all cartons. North American shipments containing Talon Drain Opener 1 lb. and 2 lb. sizes will be shipped Consumer Commodity ORM-D; All cartons on shipments to overseas countries are required to have the proper UN Number on Bills of Lading and a Corrosive Warning Label on all cartons. North American shipments containing NOW! and QUIK! 32 oz. size will be shipped Consumer Commodity ORM-D; sizes over 32 oz. are required to have the proper UN Number on Bills of Lading and a Corrosive Warning Label on all cartons. All cartons on shipments to overseas countries are required to have the proper UN Number on Bills of Lading and a Corrosive Warning Label on all cartons. North American shipments containing Sludge•B•Gone, 32 oz. size, will be shipped Consumer Commodity ORM-D; gallon size requires the proper UN Number on Bills of Lading and a Flammable Red Label on all cartons. All cartons on shipments to overseas countries are required to have the proper UN Number on Bills of Lading and a Flammable Red Label on all cartons.

**CARRIERS:** J.C. Whitlam Manufacturing Company reserves the right to choose freight carriers on all prepaid shipments.

**PRIOR NOTIFICATION:** Charges by a carrier for notification prior to delivery, will be the responsibility of the customer.

**PALLETIZATION:** J.C. Whitlam Manufacturing Company will palletize and stretch-wrap. Customer will be notified of any additional charges prior to shipment. When receiving shipment, count and sign for individual cartons. All pallets shipped as individual cartons.

**SHORTAGES & DAMAGE CLAIMS:** Examine shipments on receipt for shortages or damage and file claims immediately with carrier. All damages or shortages must be noted on the carrier's Bill of Lading when receiving shipment. We will assist you in filing claims. Bills of Lading covering shipments are an acknowledgment by the Carrier of receipt of product in apparent Good Condition. If shipment is not delivered to you in good condition, it is your responsibility to make a claim against the Carrier. Always have the shortage or damage noted by the delivery driver on both the drivers and your copy of the delivery receipt with the drivers signature. These notations should also appear on the freight bill. Make your claim promptly to the Carrier, for the Carrier will not consider a claim unless presented within ninety days from date of delivery. If the shipment is to be rejected, notify J.C. Whitlam Manufacturing Company. If you accept from a Carrier a shipment that is short or damaged, without having proper inspections and notations made, you do so at your own risk. If there is concealed damage, call the Carrier's representative or agent to view the damage and have him mark the freight bill. Also obtain a copy of his inspection report. Concealed loss or damage, discovered after delivery of shipment, must be reported to Carrier's agent or representative immediately upon discovery, but no later than 15 days after receipt. Claims for loss or damage can not be deducted from our invoice, nor payment of invoice withheld awaiting adjustment of such claims.

**LIMITED GUARANTEED SALE AND RETURN POLICY:** No returns accepted without prior authorization being RECEIVED from our CORPORATE OFFICES in Wadsworth, Ohio. When Authorization is given, an Authorization Number will be issued which must appear on Shipping Documents. A trucking company will be designated which must be used. Any deviation from these requirements may cause the shipment to be refused. Products may be returned within two years of purchase date except for plastic solvent cements and cleaners, which may be returned within twelve months of purchase date. Freight must be paid by purchaser and returned in resalable condition. A repacking charge may be applied.



**"TALON" TOWER OF TOWELS**  
Stock Code: TFB80D  
See Page 16

**STANDARD PACKAGING: WHITLAM CHEMICAL AND PLUMB-PRO DIVISION PRODUCTS ARE SHIPPED IN FULL CASE QUANTITIES ONLY.**

**WARRANTY: J.C. WHITLAM MANUFACTURING CO. guarantees Whitlam and Plumb-Pro products to be in compliance with acceptable commercial standards for material and workmanship for a period of one (1) year from date of purchase, unless noted in price catalog. Complete products must be returned for credit or replacement.**

**This sheet supersedes all previous price catalogs. Prices and specifications subject to change without notice. Our liability on all products not to exceed amount of invoice value.**



**"GLUE-WASH" PUMICE HAND CLEANER 16 OZ. - 12 PACK**  
Stock Code: GWP16  
See Page 16



**"TALON" HAND CLEANER 16 OZ. - 12 PACK**  
Stock Code: THC16  
See Page 16



**"BLUE MAGIC"  
THREAD SEALANT  
1/2 PINT - 12 PACK**  
Stock Code: IG8A  
See Page 8



**"SELECT-UNYTE"  
THREAD SEALANT  
1/2 PINT - 12 PACK**  
Stock Code: TF8A  
See Page 8



**"T-U TYPE 555"  
THREAD SEALANT  
1/2 PINT - 12 PACK**  
Stock Code: TU8A  
See Page 8



**"TALON"  
THREAD SEALANT  
1/2 PINT - 12 PACK**  
Stock Code: TAL8A  
See Page 9



**"TALON"  
PROFESSIONAL HIGH  
DENSITY PTFE TAPE**  
Stock Code: TL1429,  
TLW1429 and TLX1429  
See Page 10



**"TAPE-UNYTE"  
PTFE TAPE  
12 PACK**  
See Page 10



**"BLUE MAGIC"  
THREAD SEALANT  
2 oz. TUBES  
12 TUBES PER DISPLAY  
6 DISPLAYS PER CASE**  
Stock Code: IG2  
See Page 8



**"SELECT-UNYTE"  
THREAD SEALANT  
2 oz. TUBES  
12 TUBES PER DISPLAY  
6 DISPLAYS PER CASE**  
Stock Code: TF2  
See Page 8



**"TYTE-UNYTE"  
THREAD SEALANT  
2 oz. TUBES  
12 TUBES PER DISPLAY  
6 DISPLAYS PER CASE**  
Stock Code: T2  
See Page 8

**First, a little nostalgia.** It can be hard to grasp how different life was in the year 1900. The light bulb, telephone and automobile were still new; and airplanes, moving pictures, and even paper clips were still only inventors' dreams.

**But the world wasn't perfect.** As shocking as it sounds, plumbers of that time used poisonous lead pastes to seal pipes.

**A solution was at hand.** In 1900, J.C. Whitlam II solved the problem with an invention he called "Tyte-Unyte®," the world's first non-poisonous thread compound. This formula was so enduring that today, it is still the standard of the plumbing industry.

**One thing led to another.** Tyte-Unyte® led to Select-Unyte, Blue Magic, Pack-Unyte, and many other products, including our new TALON Pipe Thread Compound. Today, J.C. Whitlam and its divisions, Whitlam Chemical and Plumb-Pro tools, provide hundreds of sealing compounds, lubricants, tape, packing, tools and other products for professionals in plumbing, heating, refrigeration and irrigation.

**Whitlam today.** Our companies are stronger than ever, with consistent quality production, innovation in chemical engineering and reliable customer service. Together, these make Whitlam a source you can trust for a long time to come.



**When you consider the long history of Whitlam Manufacturing,** you can be sure we will be here for you, just as we have been for more than 100 years.

**Reliable service.** We have always provided reliable service, but today we are dedicated, more than ever, to providing these services:

- convenient, friendly customer relationships
- fast, cost-conscious delivery options
- complete product information
- precise test data

**Engineering expertise.** You should also know that the product quality you depend on is based on chemical engineering expertise. We maintain quality control by testing products during manufacture, assure that packaging and shipping conditions are correct for the product, and explore new ways to bring you the next generation of products.

### **Innovative solutions and private labels.**

We continue to develop custom solutions and to offer private labeling to meet your specific needs. After all, we were founded on innovation, and its spirit has never left us.

Sincerely,  
Jack C. Whitlam IV  
President





## INDEX BY PRODUCT

PRODUCT	PAGE	PRODUCT	PAGE	PRODUCT	PAGE
ABRASIVES	13	HEATING PRODUCTS	20 - 21	SHOVELS	25
ABS SOLVENT CEMENTS	5	HIGHSIDE CHEMICALS	22	SEALANT	12
ACID BRUSHES	34	HOSES	15	SLEDGE HAMMERS	24
ALL PURPOSE CEMENT	5	INSULATORS, METAL STUD	35	SOFT JAW WONDER PLIERS	28
ANTI-FREEZE	20	INTERNAL PIPE CUTTERS	32	SOFT TOUCH PLIERS	28
ANTI-SEIZE COMPOUNDS	9	LEAK DETECTOR	21	SOIL PROBE TIPS	26
BOILER PRODUCTS	21	LEAK TRACER DYES	33	SOIL PROBES	26
BOTTLES	34	LEVELS	35	SOLDER FLUX	14
BREAK-A-WAY BOLTS	17	LONG NOSE PLIERS	27	SOLVENT CEMENT CHART	7
BRUSHES	13 & 34	MARKING GUN	33	SPRAYERS	34
CABLE SAWS	29	MARKING MACHINE	33	STRAPS	24
CANS	34	MARKING WAND	33	STUD PUNCH	35
CAULKING GUNS	12	MASON TWINE	35	SWABS	34
CAULKS	12	MEASURING TAPE	35	"T-HANDLE" CABLE SAW	29
CAUTION TAPE	35	METAL STUD PUNCH	35	TALON TOWER OF TOWELS	16 & 39
CEMENT CHARTS	6 - 7	METER KEYS	26	TANK TO BOWL BOLT SETS	17
CHANNELOCK	27	NO HUB TORQUE WRENCH	28	TAPE, PTFE	10
CLEAR CLEANER	6	OILS	11	TELESCOPIC BASIN WRENCH	28
CPVC SOLVENT CEMENTS	5	OPEN MESH CLOTH	13	THREAD SEALANTS	8 - 9
CUTTING OILS	11	PAINT	11 & 33	TOILET FLANGE BOLTS	17
DAP®	12	PAINT STYLE BRUSHES	34	TRAP PRIMER	15
DAUBERS	34	PICK MATTOCK	24	URINAL CLEANER	16
DESCALER	15	PIPE CUTTERS	30 - 31	VALVE KEY, 4-WAY	35
DISPENSERS/HAND CLEANERS	16	PIPE FITTING REAMERS	32	VALVE WRENCHES, TELESCOPIC	26
DISPLAYS	36 - 40	PIPE GASKET LUBE	14	VENT SCREENS	32
DRAIN CLEANERS	16	PIPE JOINT COMPOUNDS	8 - 9	WATER HEATER ELEMENT WRENCH	28
DRAIN OPENERS	16	PIPE JOINT LUBRICANT	14	WATER SOLUBLE FLUX	14
EPOXY PUTTY	10	PIPE PLIERS	27 - 28	WATERLESS URINAL ODOR BLOCKER	15
FITTING BRUSHES	13	PIPE WRAP TAPE	35	WAX RINGS	18 - 19
FLANGE BOLTS	17	PLASTIC PIPE CUTTERS	30 - 31	WIRE PULLING TWINE	35
FLASHING CEMENT	11	PLIERS	27 - 28	WRENCHES	28
FLOW DISPLAY	15	PLUMBER'S PUTTY	10		
FLUX	14	PRIMERS	6		
FLUX BRUSHES	34	PTFE TAPES	10		
FUEL OIL ADDITIVE	21	PUMPS	15		
FURNACE CEMENT	21	PUTTY	10		
GAS LINE TAPE	10	PVC CEMENTS	3 - 6		
GASKET LUBE CHART	14	PVC SAW	29		
GASKET LUBE PASTE	14	SAND CLOTH	13		
GASKETS	19	SAW BLADES	29		
HACKSAWS AND BLADES	29	SAWS	29		
HAND CLEANERS	16	SCREWDRIVER BITS	23		
HAND WIPES	16	SCREWDRIVERS	23		
HEAT PROOF GREASE	14	SILICONE GREASE	14		

## INDEX BY STOCK CODE

J.C. WHITLAM MFG. CO. MANUFACTURING QUALITY CHEMICAL PRODUCTS SINCE 1900		STOCK CODE	PAGE	STOCK CODE	PAGE
<b>STOCK CODE</b>	<b>PAGE</b>	FLOW - DESCALER	15	FP - FREEZE-POINT -100, ANTI-FREEZE, CONCENTRATE	20
ABS - ABS YELLOW CEMENT	5	FLOW-COM	15	FPGL - 48% GLYCERINE ANTI-FREEZE	20
AF - ANTI-FREEZE, SOLUTION	20	FLOW-DISPLAY	15	FPPG - 38% PROPYLENE GLYCOL ANTI-FREEZE	20
AL - ABS CEMENT	5	FLOW-KIT	15	FT - SOLDER FLUX	14
AP - ALL PURPOSE CEMENT	5	FOS1RB - WAX RING, REGULAR WITH BOLTS	18	GC - TURF COLORANT	33
APR - ALL PURPOSE CEMENT	5	FOS1RB-D - WAX RING, REGULAR WITH BOLTS	18	GL - GRAY MEDIUM PVC CEMENT	3
BA - BREAK-A-WAY TOILET BOLTS	17	FOS1RJ - WAX RING, REGULAR JUMBO	18	GLP - GASKET LUBE	14
BD - ASPHALT PAINT	11	FOS1RP-D - WAX RING REGULAR WITH BOLT KIT	18	GT260 - GAS LINE PTFE TAPE	10
BF - FLASHING CEMENT	11	FOS1RU - WAX RING, REGULAR WITH URETHANE	19	GT520 - GAS LINE PTFE TAPE	10
BFC - FLASHING CEMENT	11	FOS1SB - WAX RING, FLANGED WITH BOLTS	18	GWP - HAND CLEANER	16
BT - BOILER TREATMENT	21	FOS1SB-D - WAX RING, FLANGED WITH BOLTS	18	HDP - HEAVY DUTY PVC CEMENT	3
C - CLEAR CLEANER	6	FOS1SJ - WAX RING, FLANGED JUMBO	18	HPG - GREASE	14
CF - COPPER FITTING, WIRE HANDLE BRUSHES	13	FOS1SJB-D - WAX RING, FLANGED JUMBO WITH BOLTS	18	HPL - CLEAR HEAVY BODIED PVC CEMENT	3
CP - COPPER FITTING, SOLID HANDLE BRUSHES	13	FOS1SP-D - WAX RING, FLANGED WITH BOLT KIT	19	HS - HIGHSIDE CHEMICALS	22
CPG - CPVC CEMENT, GRAY	5	FOS1SU - WAX RING, FLANGED WITH URETHANE	19	HT - FURNACE CEMENT	21
CPL - CPVC CEMENT, YELLOW	5	FOS2U - URINAL GASKET WITH URETHANE	19	IG - THREAD SEALANT	8
CPV - CPVC CEMENT, ORANGE	5			IR - IRRIGATION PVC CEMENT	4
CU - ANTI-SEIZE LUBRICANT	9			JAO - SAND CLOTH	13
DTM - DIRECT TO METAL PAINT	11			LTDB - LEAK TRACING DYE, BLUE	33
EPP - EPOXY PUTTY	10			LTDG - LEAK TRACING DYE, GREEN	33
EPS - EPOXY PUTTY	10			LTDL - LEAK TRACING DYE, RED	33
F520 - PTFE TAPE	10			LD - LEAK DETECTOR	21
FB - FLANGE BOLTS	17			LDS - LEAK DETECTOR, SPRAY	21
FF - ANTI-FREEZE, CONCENTRATE	20			MT - PUTTY	10
				NI - ANTI-SEIZE LUBRICANT	9

# INDEX BY STOCK CODE -CONT.

STOCK CODE	PAGE	STOCK CODE	PAGE	STOCK CODE	PAGE
NW - DRAIN OPENER	16	#21 - CUTTER BLADE	31	#326 - SHOVEL, ROUND POINT	25
OM - OPEN MESH CLOTH	13	#22 - CUTTER SPRINGS	31	#334 - 8# SLEDGE HAMMER	24
PCL - CLEAR PRIMER	6	#24 - 1/2" PIPE INSULATOR	35	#336 - 12# SLEDGE HAMMER	24
PCW - WEATHERPROOF PVC CEMENT	4	#25 - 3/4" PIPE INSULATOR	35	#337 - 16# SLEDGE HAMMER	24
PGL - HEAVY BODIED PVC CEMENT, GRAY	3	#26 - 1" PIPE INSULATOR	35	#367 - CAUTION TAPE, 1000'	35
PL - CLEAR MEDIUM BODIED PVC CEMENT	3	#33 - 4-WAY VALVE KEY	35	#368 - CAUTION TAPE, 200'	35
POW - THREAD SEALANT	9	#37 - CUTTER PIN	30	#389 - SOFT TOUCH JAWS	28
PPL - PURPLE PRIMER	6	#38 - 1-5/8" RATCHET CUTTER	30	#391 - ROUND WONDER JAWS	28
PRL - CLEAR REGULAR PVC CEMENT	3	#39 - CUTTER BLADE	30	#392 - SQUARE WONDER JAWS	28
PSA - ATHLETIC INVERTED MARKING PAINT	33	#40 - CUTTER SPRING	30	#393 - SOFT TOUCH PLIERS	28
QK - DRAIN CLEANER	16	#41 - SCREWDRIVER BIT	23	#394 - SOFT JAW PLIERS	28
QS - PIPE JOINT LUBE	14	#42 - SCREWDRIVER BIT	23	#395 - SOIL PROBE TIPS	26
S1WR - WAX RING, REGULAR	18	#43 - SCREWDRIVER BIT	23	#397 - 6' METER KEY	26
S1WS - WAX RING, FLANGED	18	#44 - SCREWDRIVER BIT	23	#398 - METAL STUD PUNCH	35
S260 - PTFE TAPE	10	#46 - MASON TWINE	35	#399 - 6' VALVE WRENCH, TELESCOPIC	26
S520 - PTFE TAPE	10	#48 - CAULKING GUN	11	#400 - 7' METER KEY	26
S1296 - PTFE TAPE	10	#49 - WIRE PULLING TWINE	35	#401 - 8' METER KEY	26
SB - POOL & SPA PVC CEMENT	4	#56 - CAULKING GUN	11	#402 - 8' VALVE WRENCH, TELESCOPIC	26
SBG - FUEL OIL ADDITIVE	21	#58 - 2# SLEDGE HAMMER	24	#403 - 7' METER KEY, 1-1/4" WRENCH	26
SG - MULTI-PURPOSE SILICONE GREASE	14	#64 - 20" METER KEY	26	#404 - 3 IN 1 SERVICE WRENCH	26
SH - HI-TEMP ANTI-FREEZE SOLUTION	20	#65 - 42" METER KEY	26	#500 - RUBBER HOSES	15
SLIME - GASKET LUBE	14	#67 - HACKSAW	29	#501 - RUBBER HOSES	15
SST260 - STAINLESS STEEL PTFE TAPE	10	#91 - CUTTER SPRINGS	30	#704 - MARKING GUN	33
SSTW520 - STAINLESS STEEL PTFE TAPE	10	#92 - CUTTER SPRINGS	31	#705 - MARKING WAND	33
ST - THREAD SEALANT	8	#118 - 1/2" FITTING REAMER	32	#B16 - PINT BOTTLES	34
STS - BOILER SEALER	21	#119 - 3/4" FITTING REAMER	32	#B32 - QUART BOTTLE	34
SW260 - PTFE TAPE	10	#120 - 1" FITTING REAMER	32	#BR - BRUSHES	34
SW520 - PTFE TAPE	10	#123 - 1-1/2" FITTING REAMER	32	#CGW - GALLON CANS	34
SW1296 - PTFE TAPE	10	#124 - 2" FITTING REAMER	32	#CGWR - GALLON ROLLER	34
SX520 - PTFE TAPE	10	#125 - 3" FITTING REAMER	32	#CGWS - GALLON SWAB	34
T260 - PTFE TAPE	10	#126 - 4" FITTING REAMER	32	#CHP - 1/2 PINT CANS	34
T520 - PTFE TAPE	10	#127 - 1-1/4" RATCHET PIPE CUTTER	30	#CPP - PINT CANS	34
T1296 - PTFE TAPE	10	#128 - CUTTER BLADE	30	#CQ - QUART CANS	34
T - THREAD SEALANT	8	#129 - CUTTER SPRINGS	30	#CQ100 - QUART CANS	34
TAL - THREAD SEALANT	9	#130 - 1-1/2" RATCHET PIPE CUTTER	31	#DHP - 1/2 PINT CPVC DAUBERS	34
TBG - GASKET & BOLT KITS	19	#131 - CUTTER BLADE	31	#DP - PINT DAUBERS	34
TC - TRANSITION CEMENT	6	#132 - CUTTER SPRINGS	31	#DPA - PINT DAUBERS	34
TDC - DRAIN OPENER	16	#143 - 10 mil PIPE WRAP TAPE	35	#DPS - PINT CPVC DAUBERS	34
TDTP - LIQUID DRAIN TRAP PRIMER	15	#145 - WATER HEATER ELEMENT WRENCH	28	#DQ - QUART DAUBERS	34
TF - THREAD SEALANT	8	#147 - SAW BLADE	29	#DQA - QUART DAUBERS	34
TFB - HAND WIPES	16	#150 - INTERNAL PIPE CUTTER	32	#EZ-725 - SUBMERSIBLE PUMP	15
THC - HAND CLEANER	16	#151 - CUTTER BLADE	32	#EZ-1150 - SUBMERSIBLE PUMP	15
TL - PTFE TAPE	10	#152 - 7-1/2" INTERNAL PIPE CUTTER	32	#GLS - APPLICATOR SWABS	34
TLW - PTFE TAPE	10	#154 - CUTTER BLADE	32	#GLSA - APPLICATOR SWABS	34
TLX - PTFE TAPE	10	#156 - 42" METER KEY	26	#MP - BLACK - AEROSOL PAINT	33
TP - POOL & REPAIR PVC CEMENT	4	#159 - 6-1/2" PIPE PLIER	27	#MP - BLUE - AEROSOL PAINT	33
TU - THREAD SEALANT	8	#160 - TELESCOPIC BASIN WRENCH	28	#MP - CLOUD WHITE - AEROSOL PAINT	33
TUBC - URINAL CLEANER	16	#161 - 9-1/2" PIPE PLIERS	27	#MP - GREEN - AEROSOL PAINT	33
TUTS - WATERLESS URINAL TRAP SEALANT	15	#162 - 10" PIPE PLIERS	27	#MP - HOT ORANGE - AEROSOL PAINT	33
TWF - WATER SOLUBLE FLUX	14	#163 - 12" PIPE PLIERS	27	#MP - PINK - AEROSOL PAINT	33
W260 - PTFE TAPE	10	#164 - 12" PIPE PLIERS	27	#MP - RED - AEROSOL PAINT	33
W520 - PTFE TAPE	10	#165 - 16" PIPE PLIERS	27	#MP - YELLOW - AEROSOL PAINT	33
WD - CUTTING OIL, DARK	11	#166 - SNAPPER CUTTER	30	#PB - BRUSHES, PAINT STYLE	34
WET - WEATHERPROOF PVC CEMENT, BLUE	4	#167 - CUTTER BLADE/PIN	30	PRO-STRIPER - MARKING MACHINE	33
WL - CUTTING OIL, LIGHT	11	#168 - 9-1/2" UTILITY PLIERS	27	#SPR - TRIGGER SPRAYER	34
WP - SAND CLOTH	13	#175 - LONG NOSE PLIERS	27	#SPRL - TRIGGER SPRAYER	34
X260 - PTFE TAPE	10	#178 - LONG NOSE PLIERS	27	#US9 - 9" RUBBER STRAP	24
XHG - HEAVY BODIED PVC CEMENT, GRAY	4	#180 - PVC SAW W/18" BLADE	29	#US15 - 15" RUBBER STRAP	24
XHW - HEAVY BODIED PVC CEMENT, WHITE	3	#181 - PVC SAW BLADE	29	#US20 - 20" RUBBER STRAP	24
		#182 - PVC SAW W/13" BLADE	29	#US31 - 31" RUBBER STRAP	24
		#183 - PVC SAW BLADE	29	#US41 - 41" RUBBER STRAP	24
		#192 - INTERNAL PIPE CUTTERS	32	#VS1 - 1" VENT SCREEN	32
		#196 - 20-1/4" PIPE PLIERS	27	#VS15 - 1-1/2" VENT SCREEN	32
		#205 - 2" PIPE RATCHET CUTTER	31	#VS2 - 2" VENT SCREEN	32
		#206 - CUTTER BLADE	31	#VS3 - 3" VENT SCREEN	32
		#207 - CUTTER SPRINGS	31	#VS4 - 4" VENT SCREEN	32
		#240 - "T-HANDLE" CABLE SAW	29	#VS6 - 6" VENT SCREEN	32
		#243 - NO HUB TORQUE WRENCH	28	#WS10 - 10' CAM BUCKLE STRAP	24
		#247 - SAW BLADE	29	#WS16 - 16' RATCHET STRAP	24
		#274 - DRAIN SPADE	25	#WS25 - 25' RATCHET STRAP	24
		#275 - DRAIN SPADE	25		
		#278 - 10# SLEDGE HAMMER	24		
		#279 - PICK MATTOCK	24		
		#280 - SOIL PROBE-FIBERGLASS	26		
		#282 - DRAIN SPADE	25		
		#283 - ROUND POINT SHOVEL	25		
		#284 - SQUARE POINT SHOVEL	25		
		#285 - SOIL PROBE-FIBERGLASS	26		
		#301 - MEASURING TAPE	35		
		#318 - TRENCH SHOVEL	25		
		#319 - TRENCH SHOVEL	25		
		#324 - WRENCH HANDLE	28		
		#325 - WRENCH SOCKET	28		

**PLUMB-PRO**  
"QUALITY TOOLS FOR THE TRADE"

STOCK CODE	PAGE
00005 - VINYL ADHESIVE CAULK	12
00057 - POLYURETHANE FOAM	12
00751 - SILICONE RUBBER SEALANT	12
08010 - RTV SILICONE - WHITE	12
08011 - RTV SILICONE - CLEAR	12
08013 - RTV SILICONE - HIGH TEMP RED	12
10012 - TOUCH 'N FOAM	12
18001 - KWIK SEAL - WHITE	12
18008 - KWIK SEAL - CLEAR	12
18013 - KWIK SEAL - ALMOND	12
18032 - KWIK SEAL - WHITE (10 oz.)	12
#4 - "6 IN 1" SCREWDRIVER	23
#5 - "6 IN 1" SCREWDRIVER	23
#12 - TORPEDO LEVEL	35
#15 - 1" PIPE RATCHET CUTTER	30
#16 - CUTTER BLADE	30
#17 - 2" PIPE RATCHET CUTTER	31
#18 - CUTTER BLADE	31
#20 - 2" PIPE RATCHET CUTTER	31

INDEX

# The Industry Standard for Over 100 Years

J.C. Whitlam Manufacturing Company began manufacturing quality chemical products in 1900 with the introduction of TYTE-UNYTE® (pronounced Tight-Unite) Thread Sealing Compound for threaded pipe connections. It was the first non-poisonous thread compound manufactured and still remains the standard of the plumbing, heating and refrigeration industry today.

Since 1900, WHITLAM has continued to be the leader in producing quality products for plumbing, heating, refrigeration, oil field and industrial applications.

The Sales Force of Whitlam and Plumb-Pro Divisions consists of over 80 Manufacturer's Representative Organizations in the U.S.A. and in 18 Foreign Countries.

This Map shows the locations of the Whitlam/Plumb-Pro sales offices in the U.S.A.

## ★ Warehouse locations

Phoenix, AZ; Livermore, CA; Rancho Cucamonga, CA; Longwood, FL; Orlando, FL; Kansas City, KS; Salt Lake City, UT; Wadsworth, OH; Carp, ON; Regina, SK; Vancouver, BC

- World Headquarters and Manufacturing in Wadsworth, OH

## ■ Conveniently located, wherever you are.

Whitlam and Plumb-Pro sales are coordinated through more than 80 teams of manufacturer representatives in the Americas and overseas.



DIVISION OF J.C. WHITLAM MANUFACTURING CO.  
200 WEST WALNUT ST., P.O. BOX 380  
WADSWORTH, OH 44282-0380

**U.S. & Canada**  
Phone: 1-800-321-8358  
FAX: 1-800-537-0588  
[www.jcwhitlam.com](http://www.jcwhitlam.com) • email: [sales@jcwhitlam.com](mailto:sales@jcwhitlam.com)

**International**  
Phone: 1-330-334-2524  
FAX: 1-330-334-3005